

HE-VA Auto-Controller Variable Rate Drill Control Pro-Series 8000i Artemis

Electromagnetic Compatibility (EMC)



This product complies with Council Directive 2004/108/EEC when installed and used in accordance with the relevant instructions.

IMPORTANT, READ THIS BEFORE USING THE PS ARTEMIS

The Pro-Series Artemis installation is a part of the Precision Farming System ("the System"). It is very important that you follow the described calibration procedures before operating the Pro-Series Artemis instrument. Calibration and operation of the Pro-Series Artemis must be in accordance with these instructions. Use of the System is subject to the following disclaimer;

1. So far as is legally permissible RDS Technology ("RDS"), or its distributors, shall not be liable, whatever the cause, for any increased costs, loss of profits, business, contracts, income, or anticipate savings or for any special, indirect or inconsequential damage whatsoever (death or personal injury excluded).
2. The capabilities and functions of the Precision Farming System ("the System") are limited as set out in the specification of the System, details of which are contained in the Help files and product literature and which must be read before using the System.
3. Without prejudice to the generality of the above it is hereby acknowledged that the System is not designed nor intended to a) originate variable treatment plans or b) achieve or avoid any application rate outside application parameters, which in both cases shall be the responsibility of the operator.
4. The standard terms and conditions of RDS (except clause 7), a copy of which is available on request, apply to the supply and operation of this System.

Service and Technical Support



N. A. Christensensvej 34
DK-7900 Nykøbing Mors
Tel: +45-9772 4288
Fax: +45-9772 2112
www.he-va.com

1.	OVERVIEW	4
1.1	The Artemis system (dual motors)	4
1.2	Main functions	5
1.3	Control Modes and Data Logging	6
	Automatic Control Mode	6
	VRT (Variable-rate treatment) Control Mode	6
1.4	Menu keys	6
2.	OPERATION	7
2.1	Status Indicators	7
2.2	'MAIN' screen	7
2.2.1	Forward speed display and alarm functions	8
	Display smoothing	8
	Speed alarms on MAIN screen	8
	Maximum speed reminder	9
2.2.2	Tramlining status/functions	9
2.2.3	Advancing the bout number	9
2.2.4	Holding the bout number	9
2.3	'RATE' screen	10
2.3.1	Setting /overriding the target rate	10
2.4	'INFO' screen	11
2.5	Tramlining	11
2.6	Pre-start function	12
2.7	Metering motor – manual override/half-width drilling	13
2.8	Product calibration	13
2.8.1	Initial product calibration	13
2.8.2	'CALIBRATION NUDGE' - Adjusting the calibration factor	15
2.9	Set Fan Speed and Hopper Level alarm thresholds	15
2.10	Speed simulation	16
2.11	Select units / Rate step%	16
3.	DATA LOGGING AND VARIABLE RATE TREATMENT	17

1. Overview

1.1 The Artemis system (dual motors)

Figure 1

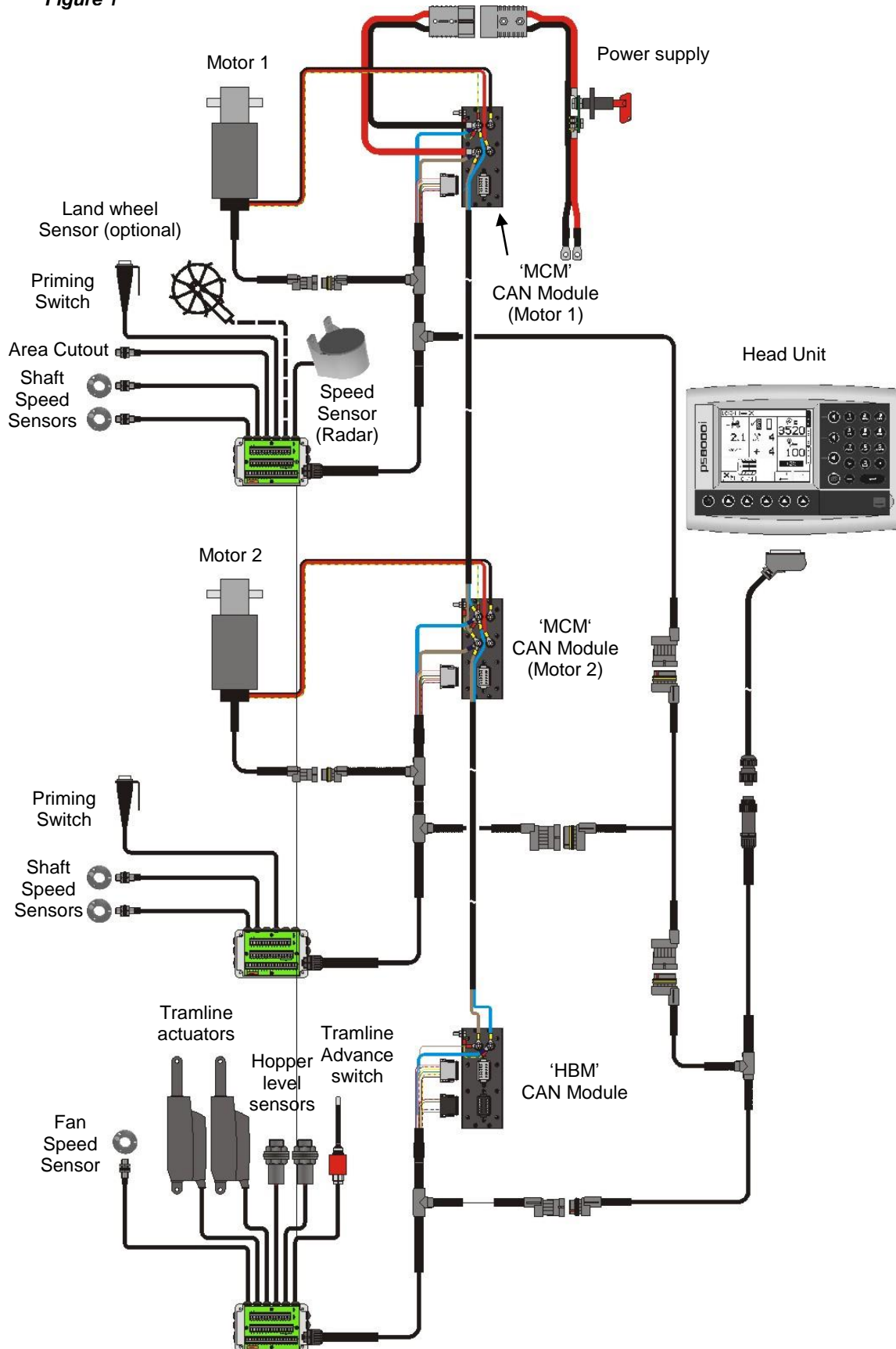

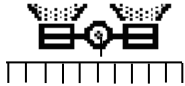

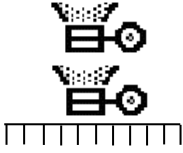
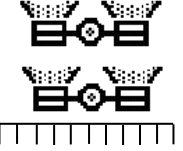

Figure 1 illustrates the various components of a typical, dual motor Artemis installation. Any of the following drill configurations (both single and dual motor) are possible, and the Artemis head unit can be configured accordingly.

PRODUCT	INSTRUMENT SETTING	METERING /MOTOR CONFIGURATION	INSTRUMENT SETTING
SEED		SINGLE MOTOR / METERING	
		SINGLE MOTOR / DUAL METERING	
		2 MOTORS / SINGLE METERING	
SEED + FERT		SINGLE MOTOR/ METERING (SEED) + SINGLE MOTOR/ METERING (FERT)	
		SINGLE MOTOR / DUAL METERING (SEED) + SINGLE MOTOR / DUAL METERING (FERT)	

Some screen pages vary slightly according to the instrument setup as shown above. Look for the above symbols next to the text.

1.2 Main functions

The Artemis is designed to allow automatic, variable rate control of any drill utilising Accord type metering units. You can at any time, also manually override the predetermined rate as field conditions require.

The basic functions are:

- Variable Rate Control
- Tramline Control
- Forward Speed Alarms
- Hopper Level alarm
- Fan Speed & alarm
- Information totals

The instrument has a special software routine that makes calibration of the metering unit(s) very easy. In the calibration mode each metering unit is controlled via a 'priming switch' to dispense the product (figure 1).

During normal operation the control system is started and stopped automatically via a magnetic sensor as the drill is put into and taken out of work. Depending on the particular installation, this sensor is triggered either by the operation of the landwheel or the markers.

1.3 Control Modes and Data Logging

Automatic Control Mode

The application rate is automatically regulated as forward speed varies, to ensure that the actual application rate constantly matches a preset target rate. The application rate can be manually nudged up and down from the target rate as required.

Field data ("job summaries") can be logged and are stored in the instrument memory. Up to 75 summaries can be stored. With a GPS receiver and SD data card, as well as creating a job summary, you can also log the vehicle route and application data to a "dynamic log" file on the SD card. The job summary data is also appended to this file.

VRT (Variable-rate treatment) Control Mode

This enables the system to be controlled via treatment instructions prepared using Precision Farming software in conjunction with DGPS position data. To enable fully automatic variable-rate treatment for Precision Farming applications, the PS 8000i requires a suitable DGPS receiver and a formatted SD data card to implement treatment plans generated in the Precision Farming software.

A work record file is automatically created on the card to log data confirming the actual treatment. The job summary data is also appended to this file, which can be viewed in the Precision Farming software

1.4 Menu keys

All instrument functions are accessed by nine menu keys adjacent to the LCD display.

Figure 1

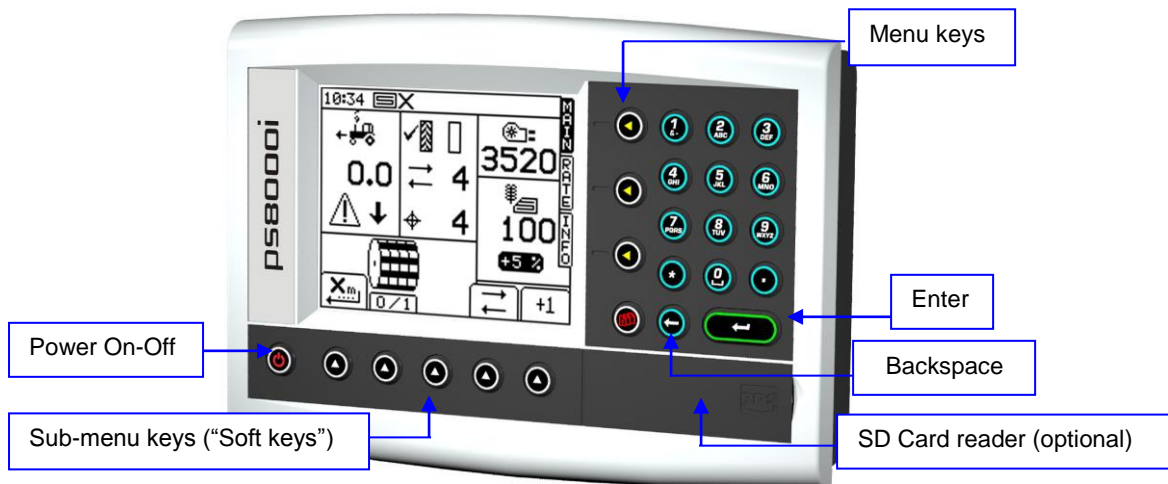

The four menu keys to the right of the screen (figure 1) access the primary screen pages (those viewed during normal operation). There are three primary screens MAIN, RATE and INFO for normal operating functions, and a SETUP screen for calibration functions.

The five sub-menu keys below the screen control the various display functions and settings for each of the primary screen pages. Text or icons are displayed adjacent to the sub-menu keys to denote their function.

2. Operation

2.1 Status Indicators

All the operating screens have a status bar at the top of screen displaying the time as well as a number of different icons. These icons indicate the following:

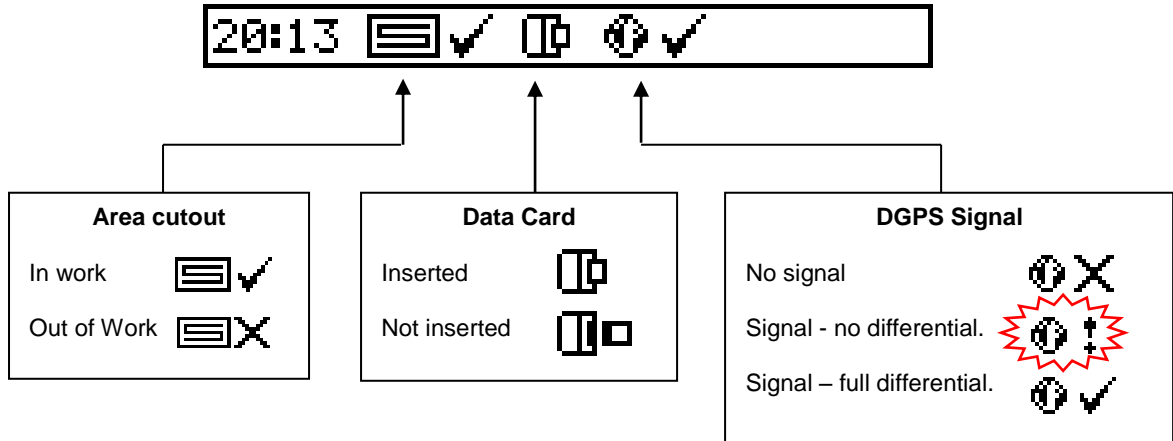

NOTE: The Data Card and GPS icons are only displayed when these functions are enabled via the SETUP menu.

2.2 'MAIN' screen

The instrument will always default to the MAIN screen on startup. The MAIN screen is divided into 5 sections displaying the following functions,

Figure 2: MAIN screen (single product / single metering)

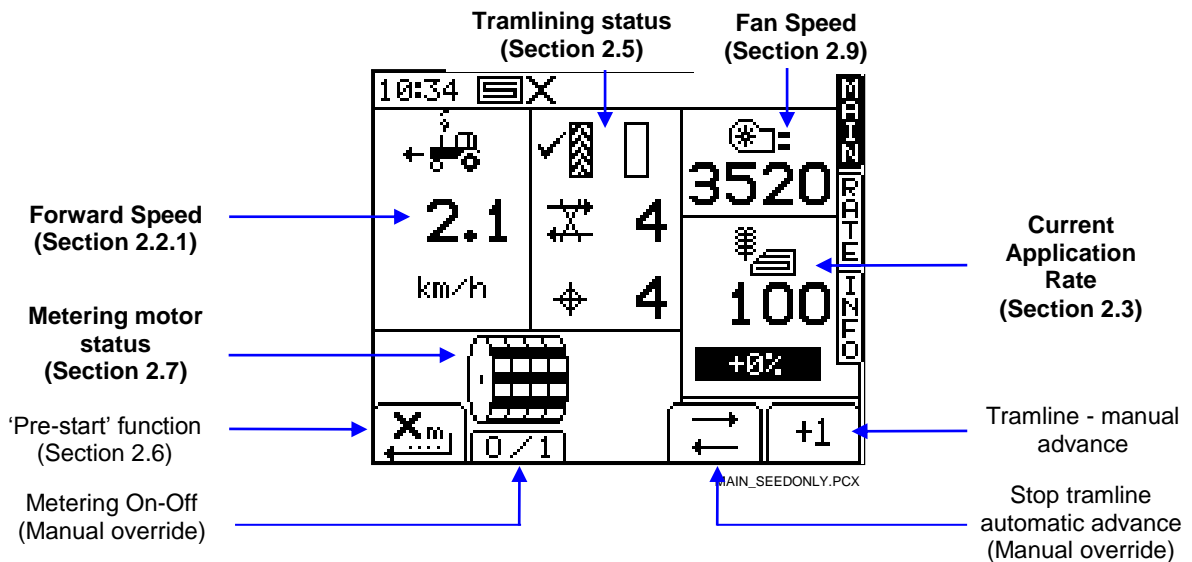

NOTE: The Metering motor status part of the display will appear differently depending on the drill configuration (ref. figures 3 and 4).

Figure 3: MAIN screen (dual product / single metering)

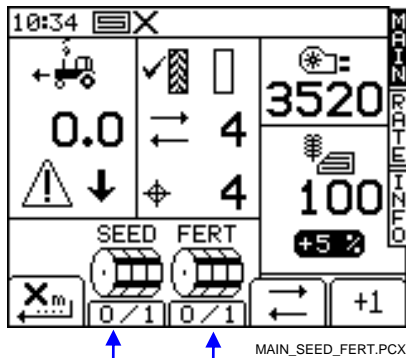

Display as figure 2 except as shown

Figure 4: MAIN screen (single product / dual metering)

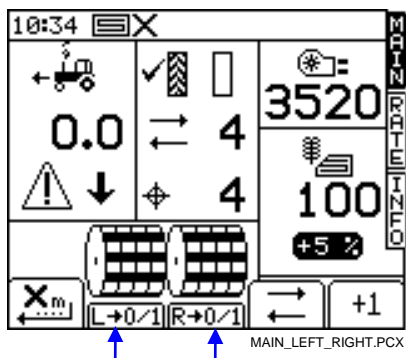

Display as figure 2 except as shown

2.2.1 Forward speed display and alarm functions

Display smoothing

Except for sudden changes in speed, the forward speed displayed at any moment will be the average speed calculated over 3 seconds.

Speed alarms on MAIN screen

The instrument is programmed with low and high forward speed alarms.

If the drill is in work and the speed is less than 0.5 km/h then this section of the MAIN display will flash the following warning and the audible alarm will beep.

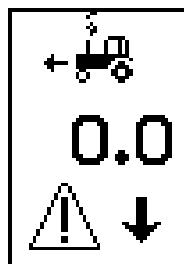

If the drill is in work and the speed is above the maximum that proportional control can achieve (indicated on the RATE screen), then this section of the MAIN display will flash the following warning and the audible alarm will beep.

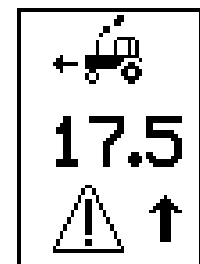

2.3 'RATE' screen

This screen allows the drilling rate to be adjusted. Either kg/ha or seeds/m² units can be set via the SETUP menu.



Figure 6: RATE screen - single product

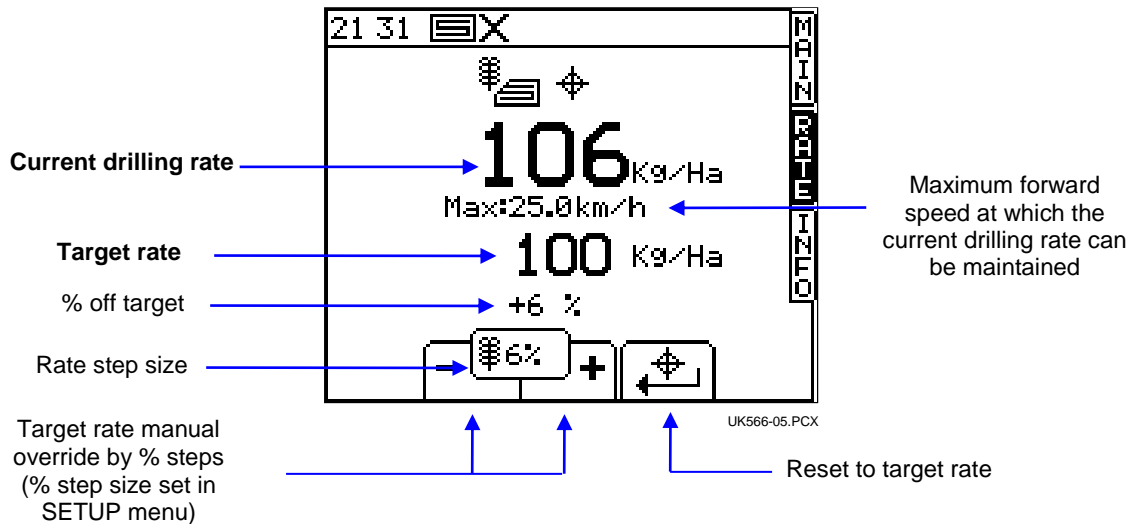
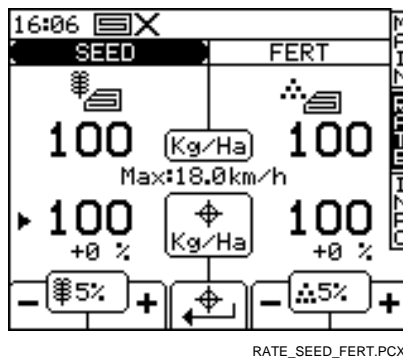

Figure 7: RATE screen - dual product



NOTE: The maximum forward speed shown is the lowest for the 2 products.

2.3.1 Setting /overriding the target rate

To set the target rate, simply enter the value and press the ENTER key to confirm.



To set the target rate or manually adjust the rate for either product, first press the ENTER key to select SEED or FERT.

The application rate on the MAIN screen is the same as that shown on the RATE screen above. If however on the rate screen, the current rate is manually adjusted above or below the target rate, then this number will flash (on for 1 second, off for 0.5 second).

When operating from a treatment plan, then this number should only flash if the instructed rate has been changed using the '+' or '-' percentage buttons on the rate screen.

To override the target rate, use the keys. The % step is configured from the SETUP menu.

To return to the target rate, press the key.

Both products are reset to their respective target rates

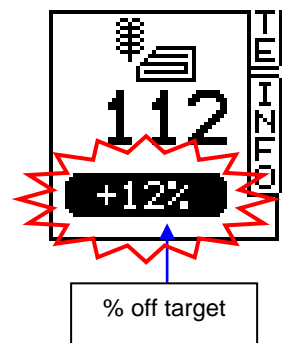

2.4 'INFO' screen

Figure 8

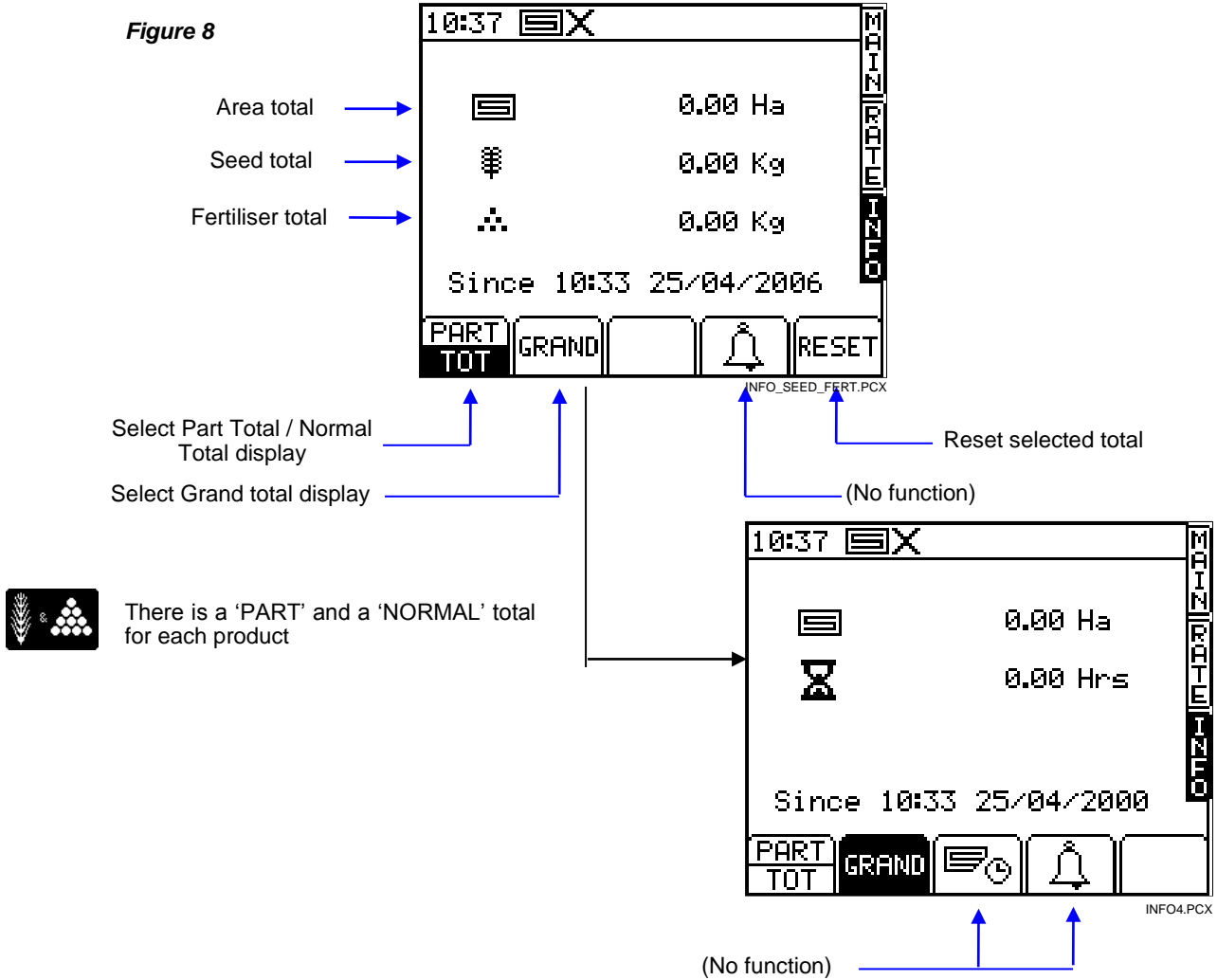

2.5 Tramlining

To set the desired tramline rhythm, select the SETUP screen and press the key.

Figure 9

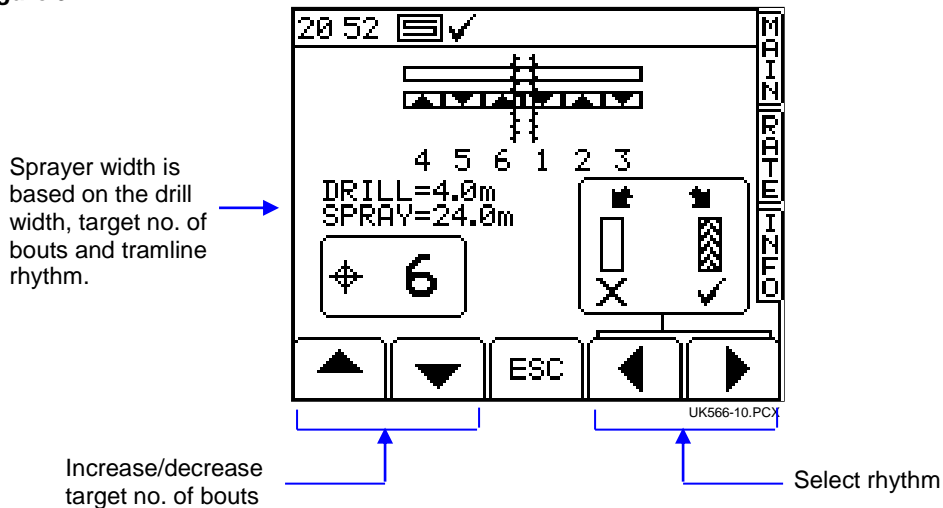

The target no. of bouts can be selected up to 10, with, symmetrical, asymmetrical left or asymmetrical right rhythm selectable.

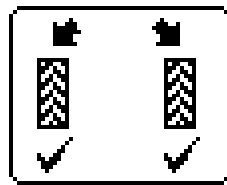

Symmetrical

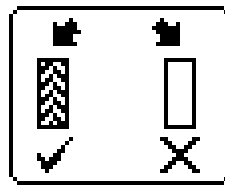

Asymmetrical left

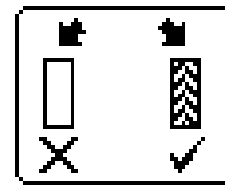

Asymmetrical right

The instrument displays the drill/sprayer width combination for the selected target no. of bouts.

Beyond 10 bouts, a number of special asymmetric rhythms can be selected to suit the following drill/sprayer width combinations.

- '8-pass' 4m drill/10.7m sprayer, 4.5m drill/12m sprayer
- '10-pass' 4m drill/10m sprayer, 6m drill/15m sprayer
- '10-pass' 4m drill/13.3m sprayer, 6m drill/20m sprayer
- '14-pass' 3m drill/14 sprayer, 4m drill/18.7m sprayer
- '16-pass' 4m drill/21.3m sprayer, 4.5m drill/24m sprayer
- '18-pass' 4m drill/18m sprayer
- '22-pass' 4m drill/29.3m sprayer

The tramline sequences ('L' – Left, 'R' – Right) are as follows:

Bout	8-pass	10-pass	10-pass	14-pass	16-pass	18-pass	22-pass
1							
2	R	R	L				
3				L	R	L	
4	L	L					L
5	L		R				
6			R				
7	R	L		R		R	
8				R	L		
9		R	L		L		
10							
11							R
12				L		R	R
13							
14					R		
15							
16						L	
17							
18							
19							L
20							
21							
22							

2.6 Pre-start function



Particularly useful in the case of a front-mounted hopper, the pre-start function helps to avoid an un-seeded area on entering work. It starts the metering unit at the calibration speed while the drill is still stationary, and 'primes' the drill so that the seed reaches the coulters just as the drill enters work.

The pre-start settings are established by trial and error tests when the system is first set up, and are adjusted via the calibration menu.

To use the pre-start feature, simply press the  key on the MAIN screen before moving off.

The metering motor will run at the calibration speed for a preset time limit, or until the forward speed exceeds 2km/hr, when full proportional control then takes over.

2.7 Metering motor – manual override/half-width drilling

Simply press the

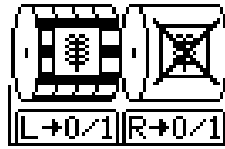

desired key(s).

The metering motor(s) can be stopped manually as desired, eg:

- (a) An area of field needs further cultivation before seeding.
- (b) In the case of a front-mounted hopper, the metering motor is switched off just before the end of the bout to clear the seed through (the opposite of the 'pre-start function').
- (c) You want to drill at half-width.

2.8 Product calibration

2.8.1 Initial product calibration

Set up the drill in the usual way for a bucket test.

1. From the SETUP screen, press the  key.
- 2a. If the instrument is configured for dual products, first select the product you want to calibrate (fig.10).



Figure 10: Dual product/Single metering



- 2b. Or if configured for dual metering, select the metering unit to be calibrated (fig. 11).

Figure 11: Single Product/Dual metering



3. Otherwise, select the desired units then enter the weight required to be metered out (fig.12) and press ENTER. The metering unit will then operate at the programmed calibration speed to dispense the correct amount of product, then stops. The instrument then displays a weight figure based on the existing programmed product calibration factor.

NOTE: If a priming switch is employed for calibration the calibration routine will commence from fig. 13.

4. Weigh the contents of the container, and then enter the *ACTUAL* weight dispensed (fig. 14) and press ENTER to confirm.

Figure 12

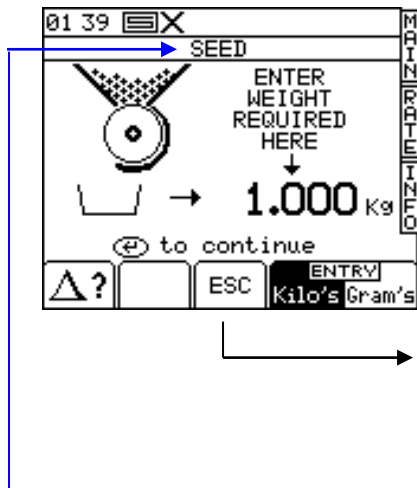

Figure 13

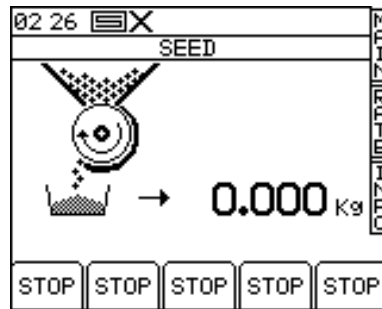
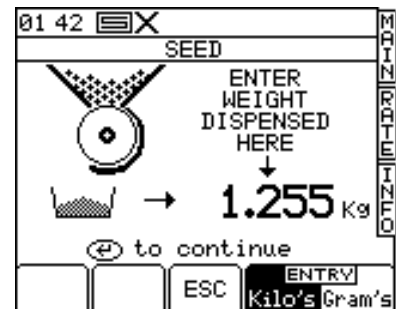

Figure 14



NOTE: The heading will be either SEED / FERT / LEFT / RIGHT according to steps 2a , 2b.

5. Press ENTER again for the instrument to re-calculate and display the new calibration factor in kg/rev, the error %, and the maximum forward speed that is permissible based on the application rate set for the product (fig.15).

Figure 15



6. Press ENTER again to confirm and store the new calibration factor, or press ESC to return to the SETUP menu screen.

It is recommended to reset the PART TOTAL to zero before commencing drilling. This will enable you after drilling an area, to quantify any error in the calibration factor by logging the theoretical amount of product used against a known amount used (a whole bag for example).

You can then adjust the calibration factor precisely, if necessary (section 2.5.2).

NOTE: Systems fitted to 'Accord' type metering mechanisms.

When changing from a low rate to a high rate i.e. 3kg/ha to 100kg/ha use the following procedure:

1. Move the metering slide to a position for the higher rate.
2. Operate the product calibration routine, dispense a suitable amount of product and enter the weight gained. The error will be considerable but press ENTER to correct the calibration factor and continue (see FIG 15).
3. Now program the required application rate (see SECTION 2.3).
4. Perform the product calibration routine again, the error this time will be marginal. Accept the error and begin drilling.



When changing from a high rate to a low rate i.e. 100kg/ha to 3kg/ha use the following procedure:

1. Move the metering slide to a position for the lower rate.
2. Operate the product calibration routine and enter the weight gained. If using the priming switch simply dispense a small amount of product and enter the weight. The error will be considerable but press enter to correct the calibration factor and continue (see FIG 15).
3. Now program the required application rate (see SECTION 2.3).
4. Perform the product calibration routine again this time dispensing a suitable amount of product. The error this time will be marginal. Accept the error and begin drilling.

2.8.2 'CALIBRATION NUDGE' - Adjusting the calibration factor

The 'calibration nudge' procedure enables you to adjust the existing calibration factor without having to redo a bucket test.

1. First note down the PART TOTAL for the product displayed in the INFO screen. This is the theoretical quantity that the instrument has calculated.

From the SETUP menu, press either the  key (CAL. CHECK), or the  key (DRILL SETUP).



If the instrument is configured for dual products, first select the product you want to calibrate (fig. 10).



If configured for dual metering units, likewise, first select the left or right unit (fig. 11)

2. From either screen, press the  key to select the 'Calibration Nudge' screen (fig.16).

Figure 16



Figure 17



Figure 18

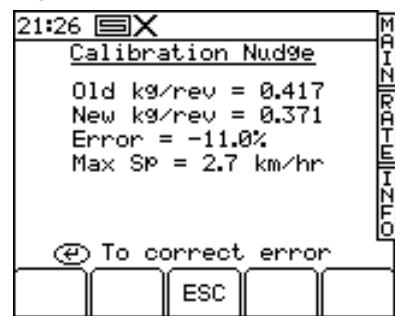

3. Enter the theoretical ('Expected') weight noted from the INFO screen at step 1 and press ENTER twice.
4. Enter the actual weight dispensed and press ENTER twice.
5. The cal factor is re-calculated and displayed along with the % error and maximum forward speed (fig.18). Press ENTER again to store the new factor.

2.9 Set Fan Speed and Hopper Level alarm thresholds

To view the alarm thresholds (fig. 19), from the SETUP menu, press the  key.

Figure 19



- ← Low fan speed alarm
- ← High fan speed alarm
- ← Hopper level alarm (ON/OFF)

To adjust the threshold, simply enter the figure and press the ENTER key.

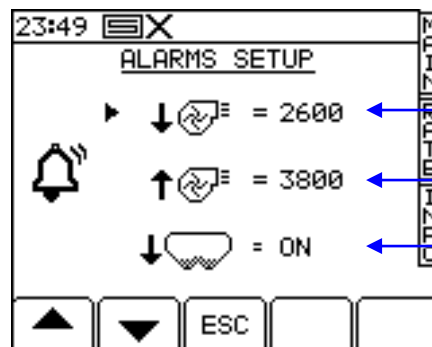
2.10 Speed simulation

If the radar speed sensor stops working, you can continue drilling by simulating a forward speed signal. Remember though that your actual forward speed should match the simulated speed as close as possible, otherwise the drilling rate will not be correct. Drive faster than the simulated speed and you will under-apply, and vice-versa.

To set the simulated forward speed, from the SETUP screen, select '1 User Setup' then '2. Speed Sensor Setup'.

Press the  key (fig.20), then enter the desired sim. speed (fig. 21).

Press the ENTER key again to start speed simulation.

Figure 20

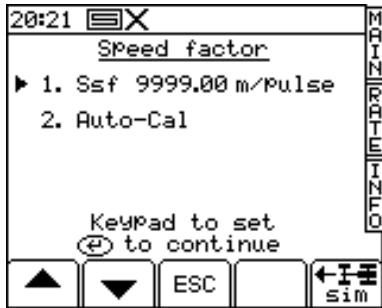
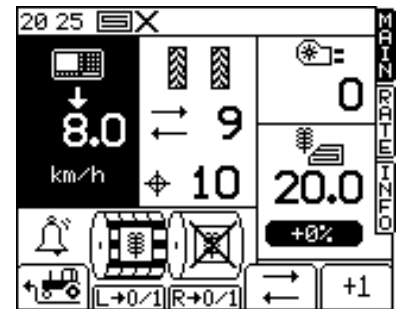

Figure 21



Figure 22



As long as speed simulation is running, the forward speed display on the MAIN screen will flash (fig. 22)

NOTE: The pre-start function works as normal with a simulated speed.

2.11 Select units / Rate step%

From the SETUP screen, select '1 User Setup' then '3. Customise'.

Figure 23

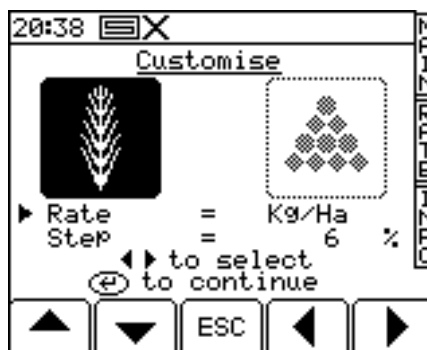

If the instrument is configured for dual products, first select the product with the LEFT/RIGHT arrow keys (fig.23).

Use the UP/DOWN arrow keys to select the parameter.

Use the LEFT/RIGHT arrow key to select the units (kg/ha or seeds/m²).

Use either the LEFT/RIGHT arrow keys to adjust the rate, or simply enter the desired figure using the keypad and press ENTER to confirm.

3. Data Logging and Variable Rate Treatment

Data Logging and Variable Rate control functions are accessed from the SETUP screen.

1. Press the  key to display the logging screen (fig. 24).
The instrument then detects the presence of the data card .
2. Press the START key to select the JOB STARTUP page (fig. 25).

Figure 24



Figure 25

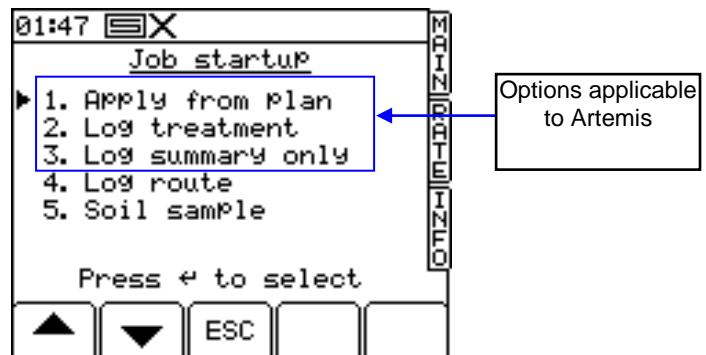

You are presented with a number of options. Only options 1,2 and 3 are applicable to the Artemis.

1. APPLY FROM PLAN (Variable-Rate Treatment or 'VRT')

- (a) The Pro-Series receives the rate from a treatment plan on the RDS Data Card Module and controls the application via the RDS control system. A full application record of the *actual* application is generated and saved on the Data Module.
- (b) The Pro-Series receives the rate from a treatment plan on the RDS Data Card Module and sends it to a third party controller, which controls the application via an OEM control system (System ERIS).
- (c) The Pro-Series receives the rate from a third-party controller and controls the application via the RDS control system (System ERIS). The Pro-Series can send back the actual application rate to the other controller

All setups allow the operator to commence a full VRT application.

For (a) and (b) a full application record of the *actual* application is generated and saved on the Data Module. The associated work record file can be viewed in the mapping/treatment plan software. Job summary data (iii) is also appended to the work record file.

2. LOG TREATMENT (Dynamic Data Logging)

A full application record is generated, logging rate and other parameters (e.g. "tags") in real time, attributing this data to a specific location. The associated "Dynamic Logging" file is viewed in the mapping/treatment plan software. A large amount of data is generated by dynamic logging and therefore must be saved onto an RDS Data Card Module. Job summary data (iii) is also appended to the dynamic logging file.

3. LOG SUMMARY ONLY (Field Data Logging)

For simple farm record keeping and traceability purposes, you can record a summary of each job or work session in the internal memory, and subsequently download directly to a PC, to a Data Module, or print to a printer. The amount of summary data for each job is small, and is saved in the internal memory. The instrument can store up to 75 individual job summaries.

Please refer to the 'GPS, Data Logging and Transfer' manual ref S/DC/500-10-384 for further information.