

Doublet-Record

KULTURHARVE
S - PINNEHARV
SPRING TINE HARROW
FEDERZINKENEGGE
VIBROCOLTEUR
ERPICE COLTIVATORE

KULTI-DAN

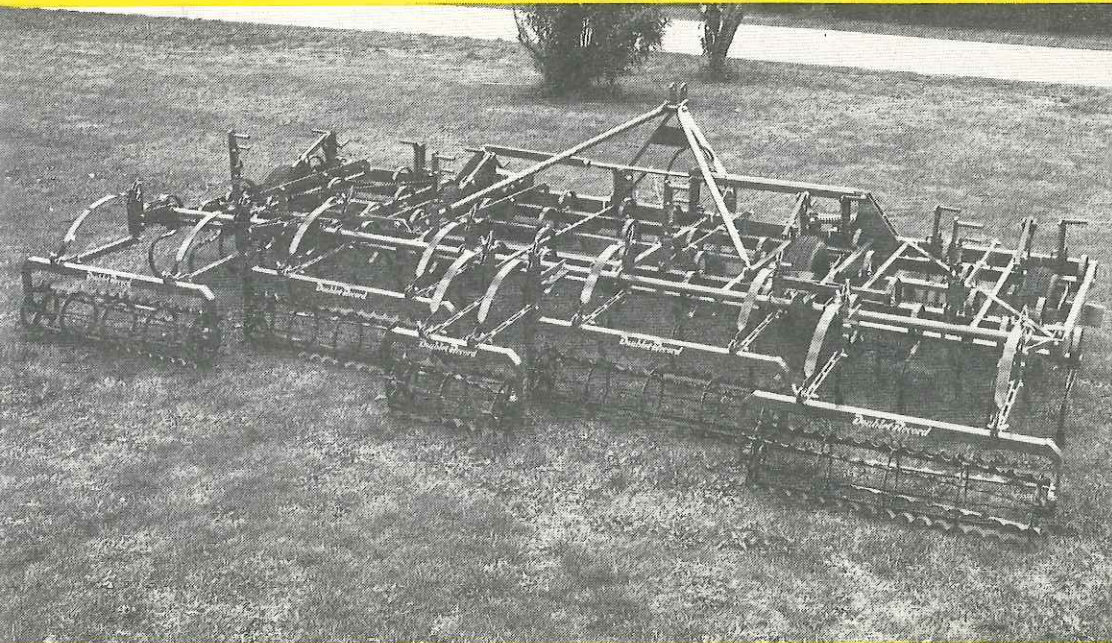

MONTAGEVEJLEDNING
OG RESERVEDELSLISTE

MONTERINGSINSTRUCTION
OCH RESERVEDELSLISTA

MOUNTING INSTRUCTIONS
AND SPARE PARTS LIST

MONTAGEANLEITUNG
UND ERSATZTEILLISTE

INSTRUCTIONS POUR LE MONTAGE
ET LISTE DE PIÈCES RECHANGE

ISTRUZIONE PER IL MONTAGGIO
E LISTA DEI RICAMBI

**DOUBLET
RECORD**



**DOUBLET
RECORD**

Ørding . DK-7990 Ø. Assels . Tlf.: 97 76 61 00 . Telefax: 97 76 61 30
International +45 97 76 61 00 . Telefax: +45 97 76 61 30

INDHOLDSFORTEGNELSE	Side
Indledning	2
Oversigt	8 - 15
Montagevejledning	16 - 17
Reservedelsliste	18 - 27
Ekstraudstyr	28 - 33
Nummerfortegnelse	34 - 35

INNEHÅLLSFÖRTECKNING	Sid
Inledning	3
Översikt	8 - 15
Montagevägledning	16 - 17
Reservdelslista	18 - 27
Extrautrustning	28 - 33
Nummerförteckning	34 - 35

TABLE OF CONTENTS	Page
General Information	4
Equipment Survey	8 - 15
Instructions for Assembly	16 - 17
Spare Parts List	18 - 27
Optional Equipment	28 - 33
Index	34 - 35

INHALTSVERZEICHNIS	Seite
Einleitung	5
Übersicht	8 - 15
Montageanleitung	16 - 17
Ersatzteilliste	18 - 27
Extraausstattung	28 - 33
Nummernverzeichnis	34 - 35

TABLE DES MATIERES	Page
Introduction	6
Vue d'ensemble	8 - 15
Instructions de montage	16 - 17
Liste des pièces de rechange	18 - 27
Accessoires en option	28 - 33
Index	34 - 35

CONTENUTO	Pagina
Introduzione	7
Sommario	8 - 15
Istruzioni per il montaggio	16 - 17
Lista dei ricambi	18 - 27
Attrezzatura supplementare	28 - 33
Elenco dei numeri	34 - 35

INDLEDNING:

Med dette katalog vil vi kort orientere om montering og brug af Deres Doublet-Record **Kulti-Dan** kulturharve.

Harveprogrammet er bygget op omkring 2 midterrammer med arbejdsbredder på henholdsvis 2.20 m og 2.80 m. Disse kan hver især forsynes med et sæt 0.60 m - 1.20 m eller 1.80 m vinger, hvorved opnås 8 forskellige arbejdsbredder fra 2.20 m til 6.40 m (se side 8-9). Størrelserne fra og med 4.60 m til 6.40 m har hydraulisk opklapning af vinger.

Montering: Se side 16 og 17.

Tilkobling.

1. Monter trækbommen i traktorens liftarme.
2. Bak traktoren hen til harven, så trækbommen er lige under trækpladernes åbning.
3. Hæv trækbommen med liften indtil låsepalerne smækker på plads.
4. Monter topstangen.

Opklapning 0.60 m vinge.

1. Fjern låsenaglen fra arbejdslåsen.
2. Vingen løftes manuelt.
3. Vingen fastlåses i transportstilling med en kraftig hårnålesplit (se pos. 5 side 21).

Opklapning 1.20 m - 1.80 m vinge.

1. Fjern låsenaglen fra arbejdslåsen.
2. Løft harven fri af jorden.
3. Vingerne hæves ved at sætte tryk på cylinderen.
4. Bemærk at låsen, der automatisk griber omkring låsetappene og fastlåser cylinderen, falder helt i bund.

Nødvendig olietryk: 1.80 m vinge ca 110 kp/cm².

NB! Stå aldrig under vinger, der hæves eller sænkes.

Sænkning.

1. Sæt tryk på cylinderen.
2. Løft cylinderlåsen så den holdes fri af låsetappene med den svingbare støttefod.
3. Tag trykket af cylinderen, og vingerne svinger langsomt ned.
4. Monter låsenaglen i arbejdslåsen.

Dybdejustering.

Afhængig af arbejdsopgaven vælges med indstillingshåndtaget en af de fire forskellige positioner for S-tændernes jordsøgende vinkel.

Harvedybden bestemmes ved hjulenes spindelregulering. Sørg for samme skalaindstilling ved alle hjul.

Topstangens længde justeres for ens harvedybde på forreste og bageste række harvetænder.

Hastighed: Bedste hastighed er 8-12 km/t.

Vedligeholdelse.

Vigtigt: Efterspænd alle bolte og møtrikker efter få timers kørsel. Derefter bør efterspænding foretages jævnlige. Lufttryk i dæk 2.2 kp/cm² - 30 lbs.

Smøring: Hjulnav og spindelregulering

Ekstraudstyr: Hydraulisk opklap til 0.60 m vinge.

Slæbeplanke.

Den fjederpåvirkede slæbeplanke er effektiv til at bryde forårsskorpen, hvorved knolde findeles, og ujævnheder jævnes. Skal jorden fældes, lægges tænderne tilbage, og slæbeplanken skal gå hårdt på jorden.

Slæbeplanken kan indstilles i højden uden brug af løse nagler og splitter.

Langfingeretterharve.

Langfingeretterharven har tænder af speciel fjederstål, der giver stor slidstyrke.

Tændernes arbejdsvinkel kan ændres, hvorved halmrester og urenheder lettere kan passere. Trykket på langfingerharven kan justeres for bedre sletning af tandsporene.

Let at hægte op når den ikke skal anvendes.

Rotor-smuldrer.

Rotorsmuldreren sletter tandsporene, og foretager en let pakning af den opharvede jord. Samtidig efterlader den et tyndt porøst jordlag, der holder på fugtigheden, hvilket giver de bedste betingelser for et godt såbed.

De enkelte sektioner overlapper hinanden, og trykket kan ændres ved hjælp af bladfjedre.

INLEDNING:

Med denna katalog vill vi kort orientera om montering och användning av Er Doublet-Record **Kulti-Dan** kulturharv.

Harvprogrammer är byggt upp omkring 2 mitt-rarmar med arbetsbredd på respektive 2,20 m och 2,80 m. Dessa kan var för sig föras med ett set vingar på 0,60 m - 1,20 m eller 1,80 m, varigenom 8 olika arbetsbredder från 2,20 m till 6,40 m uppnås (se sid. 8-9). Storlekarna från och med 4,60 m till 6,40 m har hydraulisk uppfällning av vingar.

Montering: Se sid 16 och 17.

Tillkoppling.

1. Montera dragbommen i traktorns lyftarmar.
2. Backa traktorn till harven, så dragbommen är direkt under dragplattornas öppning.
3. Lyft dragbommen med lyften tills låspärrarna smäcker på plats.
4. Montera toppstången.

Uppfällning 0,60 m vinge.

1. Flytta låsnageln från arbetslåset.
2. Lyft vingen manuellt.
3. Vingen fastlåses i transportställning med en kraftig låssprint (se pos. 5 sid 21).

Uppfällning 1,2 m - 1,8 m vinge.

1. Flytta låsnageln från arbetslåset.
2. Lyft harven fri av jorden.
3. Vingarna lyfts med tryck på hydrauliskolven.
4. Observera att låset, som automatiskt griper kring låstapparna och fastlåser kolven faller helt i botten.

Nödvändigt oljetryck: 1,8 m vinge ca 110 kp/cm². OBS! Stå aldrig under vangar, som lyfts upp eller sänks ned.

Nedfällning.

1. Sätt tryck på kolven.
2. Lyft kolvenslås så det hålls fritt från låstapparna med den svängbara stödfoten.
3. Tag trycket af kolven och vingarna svänger långsamt ned.
4. Montera låsnageln i arbetslåset.

Djupjustering.

Avhängigt av arbetsuppgiften välges med inställningshandtaget en av de fyra olika positionerna för S-pinnarnes jordsökande vinkel.

Harcdjupet bestäms med hjulens spindelreglering. Sörj för samma skalainställning vid alla hjulen.

Toppstångens längd justeras för samma harvdjup på de främre och bakre harvpinnar.

Hastighet: Bästa hastighet är 8 - 12 km/t.

Underhåll.

Viktigt: Efterspänna alla bultar och muttrar efter ett par timmars arbete. Efterspänning bör företas med jämna mellanrum. Lufttryck i däck 2,2 kp/cm² - 30 lbs.

Smörjning: Hjulnav och spindelreglering.

Extrautrustning: Hydraulisk uppfällning till 0,6 m vinge.

Sladdplanka.

Den fjäderpåverkade sladdplankan är effektiv till att bryta vårskorpan, varigenom kokor findelas och ojämnheter jämnas.

Skall jorden jämnas läggs pinnarne tillbaka och sladdan skall gå hårt på jorden.

Sladdplankan kan inställas i höjden utan användning av naglar och sprinter.

Långfingerefterharv.

Långfingerefterharven här pinne av speciellt fjäderstål, som ger stor slitstyrka.

Pinnarnes arbetsvinkel kan ändras varigenom halmrester och ogräs lättare kan passera. Trycket på långfingerharven kan justeras för bättre utslätning av tandspåren. Lätt att häkta av när den inte skall användas.

Ribbvälten.

Ribbvälten slättar tandspåren och företar en lätt packning av den uppharvade jorden.

Samtidigt kvarlämnar den ett tunt poröst jordlager, som håller på fuktigheten, vilket ger de bästa förutsättningar för en bra sätäppa.

De olika sektionerna överlappar varandra och trycket kan ändras med hjälp av bladfjädrar.

INTRODUKTION:

The following pages present a brief outline of the assembly and use of the Doublet-Record **Kulti-Dan** spring tine harrow.

The Kulti-Dan programme is built up around two centre frames, with working widths of 2.20 m and 2.80 m respectively. A set of side frames 0.60 m, 1.20 m or 1.80 m in width can be mounted to both sizes of centre frame, and working widths ranging from 2.20 m to 6.40 m can thereby be achieved (pp. 8-9).

All models with widths exceeding 4.60 m feature hydraulic folding of the side frames.

Assembly: See pp. 16 - 17.

Connecting harrow and tractor.

1. Mount the drawbar in the lifting shaft of the tractor.
2. Back the tractor up to the harrow until the drawbar is located just under the opening in the drawplates.
3. Raise the drawbar with the lifting shaft until the locking pawls snap into position.
4. Mount the upper bar.

Folding up side frames, 0.60 m.

1. Remove the locking spike from the working lock.
2. Fold up the side frames manually.
3. Lock the side frames into transport position using a strong hairpin split-pin (pos. 5, p. 21).

Folding up side frames, 1.20 m - 1.80 m.

1. Remove the locking spike from the working lock.
2. Lift the harrow clear of the ground level.
3. Fold up the side frames by activating the cylinder pressure.
4. The lock which automatically grasps the locking pawls drops to its bottom position.

Oil pressure required, 1.80 m side frame: approx. 110 kp/cm².

NB: Keep clear of side frames when folding up or down.

Folding down side frames.

1. Activate the cylinder pressure.
2. Lift the cylinder lock, holding it clear of the locking pawls with the swivel support.
3. Release the cylinder pressure. The side frames will be slowly lowered.
4. Insert the locking spike in the working lock.

Adjusting harrowing depth.

Use the adjusting lever to select the operating angle of the teeth appropriate to the work to be carried out.

The harrowing depth is regulated by means of the spindle control on each wheel. Ensure that the scale setting is the same for all wheels.

Adjust the length of the upper bar to give the same harrowing depth for both front and rear tines bars.

Speed: The optimum speed is 8-12 km/hr.

Maintenance.

It is important to re-tighten all bolts and nuts after the first few hours of operation. Re-tightening should then be carried out at regular intervals. Tyre pressure: 2.2 kp/cm² - 30 lbs.

Lubrication: Lubricate wheel hubs and spindle controls.

Optional equipment: Hydraulic folding equipment for 0.60 m side frames.

Levelling Bar.

The spring-suspended levelling bar breaks the spring-time surface crust effectively, crushing lumps and levelling the soil surface. For fine levelling the harrow is operated with the teeth pointing backwards and the drag beam exerting a greater pressure on the soil.

The height of the drag beam can be adjusted without the use of detachable spikes or split-pins.

Long-finger-harrow.

The long-finger-harrow has teeth of special spring steel for extra durability. The working angle of the tines can be adjusted to allow the passage of straw and other foreign objects in the soil. The pressure on the finger-harrow can be regulated to give the desired smoothing-over of the tines tracks.

The equipment is conveniently hung up for storage when not in use.

Crumbler-Roller.

The rotary crumbler-roller removes tines tracks and gives a light packing of the harrowed soil. It leaves a thin layer of porous soil, which retains moisture and thus provides an excellent seedbed. The individual sections overlap, and pressure can be adjusted by means of the steel springs.

Einleitung:

Mit diesem Katalog möchten wir Sie kurz über Montage und Gebrauch Ihrer Doublet-Record KULTI-DAN Federzinkenege orientieren.

Das Eggenprogramm ist so aufgebaut, daß es von 2 Tragrahmen mit Arbeitsbreiten von 2,20 bzw. 2,80 m ausgeht. Diese können jeweils mit Seitenfeldern von 0,60 m - 1,20 m oder 1,80 m versehen werden, so daß 8 verschiedene Arbeitsbreiten von 2,20 m - 6,40 m (siehe Seite 8-9) erreicht werden können. Die größten von einschließlich 4,60 m bis 6,40 m sind mit hydraulischen Vorrichtungen zum Aufklappen der Seitenfelder versehen.

Montage: Siehe Seite 16 und 17.

Ankoppeln.

1. Befestigen Sie die Zugwelle in den Unterlenkern des Tractors.
2. Fahren Sie den Traktor rückwärts so an die Egge heran, daß sich die Zugwelle direkt unterhalb der Zugplattenöffnung befindet.
3. Heben Sie die Zugwelle mit der Hydraulik soweit an, daß die Sperrklinke einrastet.
4. Montieren Sie den Oberlenker.

Aufklappen des 0,60 m Seitenfeldes.

1. Nehmen Sie den Sperrbolzen aus dem Verschluss heraus.
2. Das Seitenfeld wird manuell angehoben.
3. Das Seitenfeld wird mit einem starken Haarnadelsplint (siehe Pos. 5 Seite 21) in der Transporteinstellung arretiert.

Aufklappen des 1,20 m - 1,80 m Seitenfeldes.

1. Nehmen Sie den Sperrbolzen aus dem Verschluss heraus.
2. Heben Sie die Egge über die Erdoberfläche.
3. Die Seitenfelder werden dadurch angehoben, daß der Zylinder unter Druck gesetzt wird.
4. Achten Sie darauf, daß die Zylinderarretierung, die automatisch die Sperrzapfen umschließt und den Zylinder arretiert, ganz nach unten fällt.

Erforderlicher Öldruck: 1,80 m Seitenfeld, ca. 110 kp/cm².

NB! Stellen Sie sich niemals unter die Seitenfelder, wenn diese angehoben oder gesenkt werden.

Senken.

1. Setzen Sie den Zylinder unter Druck.
2. Heben Sie die Zylinderarretierung so weit an, daß die Sperrzapfen mit dem drehbaren Stützfuß frei gehalten werden.
3. Nehmen Sie den Druck vom Zylinder weg und die Seitenfelder drehen sich langsam nach unten.
4. Befestigen Sie den Sperrbolzen in der Verschluss.

Tiefenjustierung.

Je nach Arbeitsaufgabe wird mit dem Einstellhebel eine der vier verschiedenen Einstellungen für den Bodensuchwinkel der S-Zinken gewählt. Die Arbeitstiefe wird durch den Spindelregler der Räder festgelegt. Sorgen Sie dafür, daß die skaleneinstellung bei allen Rädern übereinstimmt.

Die Länge des Oberlenkers wird eingestellt, damit eine gleichmäßige Arbeitstiefe der vorderen und der hinteren Eggenzinkenreihen erzielt wird.

Geschwindigkeit: Die beste Geschwindigkeit sind 8-12 km/Std.

Wartung.

Wichtig: Nach einigen wenigen Betriebsstunden alle Schrauben und Muttern nachspannen. Danach sollte das Nachziehen regelmässig vorgenommen werden. Reifendruck: 2,2 kp/cm² - 30 lbs.

Schmieren: Radnabe und Spindelregler.

Extraausstattung: Hydraulische Aufklappung für 0,60 m Seitenfeld.

Planierplanke.

Die federnde Planierplanke dient zum wirkamen Aufbrechen der Frühjahrskruste, wobei Klumpen zerteilt und Unebenheiten geebnet werden. Soll der Boden geglättet werden, klappt man die Zinken zurück und die Planierplanke geht hart auf den Boden hinunter.

Die Planierplanke läßt sich in der Höhe verstellen, ohne daß dazu Werkzeug verwendet werden muss.

Zustreichегge.

Die Zustreichегge hat Zinken aus speziellem Federstahl, der ihnen eine hohe Haltbarkeit verleiht. Der Arbeitswinkel der Zinken läßt sich einstellen, so daß Strohreste und Verunreinigungen schneller hindurchfallen. Der Druck der Zustreichегge kann, zum besseren Verwischen der Zinkenspuren, eingestellt werden.

Sie läßt sich leicht hochhängen, wenn sie nicht verwendet hochhängen, wenn sie nicht verwendet werden soll.

Der Walzenkrümmer.

Der Walzenkrümmer verwischt die Zinkenspuren und packt die aufgegгte Erde leicht übereinander. Gleichzeitig hinterläßt er eine dünne poröse Erdschicht, die die Feuchtigkeit bewahrt, so daß die besten Bedingungen für ein gutes Saatbett vorhanden sind. Die einzelnen Sektionen überlappen einander und der Druck läßt sich mit Hilfe von Blattfedern verändern.

INTRODUCTION:

Nous nous proposons dans ce catalogue de vous donner de brèves indications sur le montage et l'utilisation de votre vibroculteur **KULTI-DAN Doublet-Record**.

Notre gamme se compose de 2 bâtis central de 2,20 m et 2,80 m. Chacun d'eux peut être équipé d'un jeu de rallonges de 0,60 m, 1,20 m ou 1,80 m permettant d'obtenir 8 largeurs de travail différentes allant de 2,20 m à 6,40 m. (voir pages 8 et 9). Les vibroculteurs de 4,60 m à relevage hydraulique.

Montage: Voir pages 16 et 17.

Attelage.

1. Adapter la barre d'attelage sur les bras de relevage du tracteur.
2. Amener le tracteur en marche arrière jusqu'à ce que la barre d'attelage se trouve placée des chappes d'attelage juste en dessous du vibroculteur.
3. Soulever la barre d'attelage à l'aide du relevage jusqu'à ce que les cliquets de verrouillage s'enclenchent.
4. Fixer la barre de poussée du 3ème point.

Repliage de la rallonge de 0,60 m.

1. Retirer la broche de verrouillage de la position travail.
2. Replier la rallonge manuellement.
3. Verrouiller la rallonge en position transport en la bloquant à l'aide d'une solide goupille élastique (voir pos. 5 p. 21).

Repliage des rallonges de 1,20 m - 1,80 m.

1. Retirer la broche de verrouillage de la position travail.
2. Soulever légèrement le vibroculteur.
3. Replier les rallonges à l'aide du vérin.
4. Vérifier que la sécurité de position transport soit bien verrouillée.

Pression d'huile nécessaire: Rallonge de 1,80 m env. 110 kg/cm².

NB! Ne jamais se tenir sous les rallonges de repliage pendant l'opération de repliage.

Mise en position travail.

1. Mettre le vérin hydraulique sous pression.
2. Deverrouiller la sécurité transport.
3. Couper la pression hydraulique. Les rallonges s'abaissent alors lentement.
4. Verrouiller les rallonges en position travail.

Reglage de la profondeur.

Selon le type de travail à effectuer on sélectionnera l'une des quatre positions de travail des dents à l'aide du levier de réglage. La profondeur de travail dépend également de la hauteur des roues. Veiller à l'aide de la reglette graduée que toutes les roues soient à la même position. Pour obtenir une profondeur de travail uniforme des dents avant et arrière, il convient de régler la barre de poussée de 3ème point.

Vitesse: La vitesse optimale est de 8-12 km/h.

Entretien.

Important: Resserer tous les boulons écrous après quelques heures de marche. Vérifier par la suite à intervalles réguliers qu'ils soient bien bloqués. Pression des pneus 2,2 kp/cm² - 30 lbs.

Graissage: Axe de roue et vis de manivelle.

Accessoires: Repliage hydraulique pour rallonge de 0,60 m.

Planche niveleuse.

La planche niveleuse à ressort écrété émiette et nivelle la partie supérieure de labour. Pour un meilleur nivellement du sol, incliner les dents vers l'arrière et appliquer fortement la planche niveleuse au sol.

La planche niveleuse est réglable en hauteur sans l'aide d'aucun outils.

Herse arrière à dents.

La herse arrière est équipée de dents vibrantes en acier spécial que lui confère une grande souplesse et une bonne résistance aux chocs et à l'usure. L'inclinaison des dents de herse est réglable et permet d'adapter celles-ci aux conditions de travail et d'éliminer les risques de bourrage sur matelas de paille importants. La présence de ressort de pression sur les bras support de herse permet d'augmenter la pression des dents sur le sol et de mieux effacer les sillons laissés par les dents du vibroculteur.

La herse arrière est d'autrepart facile à décrocher du vibroculteur si son emploi n'est pas utile.

Herse rotative émotteuse.

L'émotteuse rotative efface les traces de dents et comprime légèrement le sol hersé. Elle laisse après son passage une couche de terre mince et poreuse que retient l'humidité, ce qui crée les conditions optimales de germination du lit de semence.

Les différentes sections se chevauchent et la pression peut être modifiée à l'aide de ressorts à lames.

INTRODUZIONE:

Con questo catalogo desideriamo orientarvi brevemente sul montaggio e sull'uso del Vostro erpice coltivatore Doublet-Record **Kulti-Dan**.

Il programma dell'erpice è basato su due telai centrali con larghezze di lavoro rispettivamente di 2,20 m e di 2,80 m. Ciascun telaio può essere provvisto di una coppia di ali da 0,60 m - 1,20 m o 1,80 m, così da ottenere 8 diverse larghezze di lavoro da 2,20 m a 6,40 m (vedi pag. 8-9). Le larghezze da 4,60 m inclusa a 6,40 m sono dotate di sollevatore idraulico delle ali.

Montaggio: Vedi pag. 16 e 17.

Accoppiamento.

1. Montare la barra di trazione sui bracci di sollevamenti del trattore.
2. Avvicinare il trattore in retromarcia all'erpice in modo che la barra di trazione sia proprio sotto l'apertura delle piastre di aggancio.
3. Sollevare la barra di trazione col sollevatore fino allo scatto dell'innesto.
4. Montare la barra superiore.

Sollevamento dell'ala di m 0,60.

1. Sfilare la spina di blocco dall'arresto.
2. Sollevare a mano l'ala.
3. Bloccare l'ala in posizione di trasporto con una grossa coppiglia a forcilla (vedi pos. 5 pag. 21).

Sollevamento delle ali di m 1,20 e 1,80.

1. Sfilare la spina di blocco dall'arresto.
2. Alzare l'erpice in modo da essere libero da terra.
3. Sollevare le ali mettendo il pistone in pressione.
4. Assicurarsi che il meccanismo si agisce automaticamente sulle spine di blocco ed arresta il cilindro, sia in posizione di fine corsa.

Pressione idraulica necessaria: per l'ala di m 1,80 ca. 110 Kg/cm².

NBI Non stare sotto le ali mentre si sollevano od abbassano.

Abbassamento.

1. Mettere in pressione il pistone.
2. Sollevare l'arresto del pistone ruotando il fermo in modo che sia libero dalle spine di blocco.
3. Togliere la pressione dal pistone e le ali si abbassano lentamente.
4. Infilare la spina di blocco sull'arresto.

Regolazione della profondità.

Secondo la lavorazione da effettuare, scegliere con la leva una delle quattro posizioni che corrisponde all'angolo più appropriato dei denti ad S.

La profondità dell'erpice è determinata dalla regolazione a vite sulle ruote. Fare attenzione di regolare ugualmente tutte le ruote.

La lunghezza della barra superiore deve essere regolata in modo da ottenere la stessa profondità di lavoro per la prima e l'ultima fila di denti.

Velocità: La migliore velocità è di 8-12 km/ora.

Manutenzione.

Importante: Stringere nuovamente tutte le viti e dadi dopo le prime ore d'uso.

In seguito, controllare regolarmente il bloccaggio di viti e dadi. Pressione dei pneumatici: 2,2 Kg/cm² - 30 libbre/pollice².

Lubrificazione: Mozzi ruote e regolazioni a vite.

Attrezzatura supplementare: Sollevatore idraulico dell'ala di m 0,60.

Lama Livellatrice.

La lama livellatrice a caricata a molle è adatta a rompere la crosta primaverile in modo da spezzare finemente le zolle e ridurre le irregolarità. Per pareggiare la terra, regolare i denti indietro e la lama livellatrice deve premere fortemente sulla terra.

La lama livellatrice può essere regolata in profondità senza l'uso di spine e coppiglie.

Erpice supplementare a dita lunghe.

L'erpice supplementare a dita lunghe ha denti di acciaio da molle speciale, che assicura una elevata resistenza all'usura.

L'angolo di lavoro dei denti può essere variato in modo da lasciar passare facilmente resti di paglia ed impurità.

La pressione sull'erpice a dita lunghe può essere regolata per pareggiare i solchi dei denti.

Facile da sganciare quando non si impiega.

Sbriciolatore a rotore.

Pareggia i solchi dei denti e comprime leggermente la terra dopo il passaggio dell'erpice. In pari tempo lascia un sottile strato di terra poroso che trattiene l'umidità creando così le migliori condizioni per la semina.

Le singole sezioni si ricoprono reciprocamente e la pressione può essere variata a mezzo di molle piatte.

2,20 m

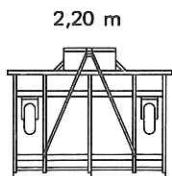

3,40 m

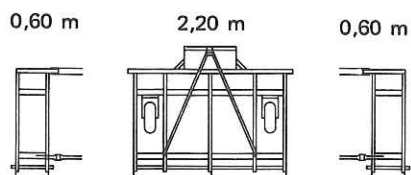

4,60 m

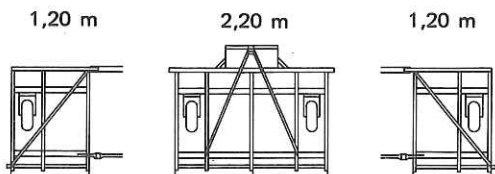

5,80 m

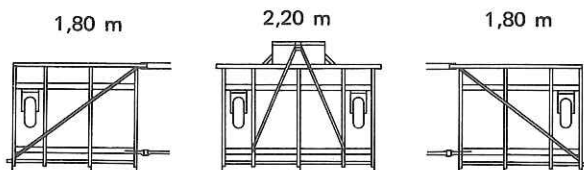

KULTURHARVE
S - PINNEHARV
SPRING TINE HARROW
FEDERZINKENEGGE
VIBROCOLTEUR
ERPICE COLTIVATORE



ARBEJDSBREDDE
WORKING WIDTHS
ARBEITSBREITE
LARGEUR DE TRAVAIL

2,80 m

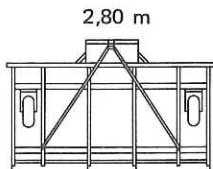

4,00 m

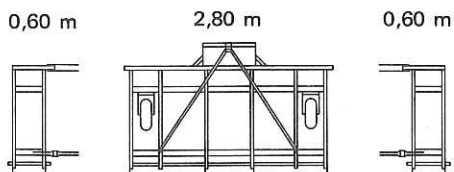

5,20 m

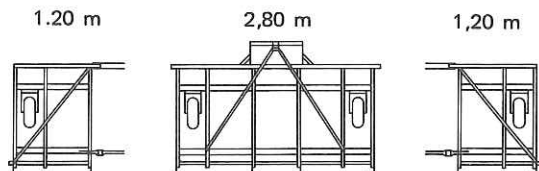

6,40 m

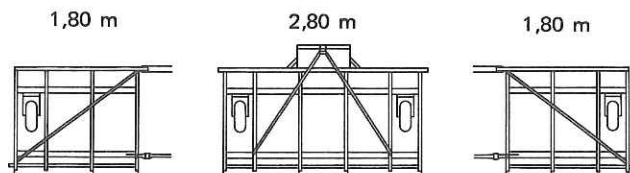

REGULERINGSBESLAG ADJUSTING FITTINGS EINSTELLBESCHLAG GARNITURE DE REGLAGE	Venstre Left Links Gauche		Højre Right Rechts Droite		Set bagfra Rear view Von hinten Vu D'arriere
BESPÆNDING ASSEMBLY FITTINGS BESPANNUNG ATTELAGE	Type 1 Type 1 Typ 1 Modele 1		Type 2 Type 2 Typ 2 Modele 2		

2,20 m

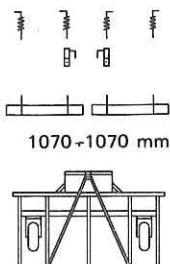

3,40 m

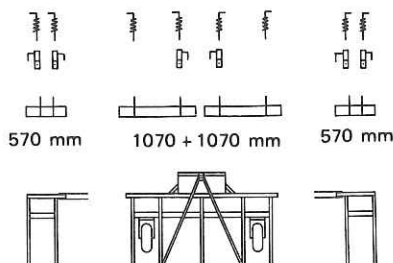

4,60 m

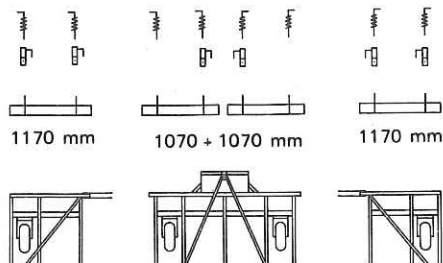

5,80 m

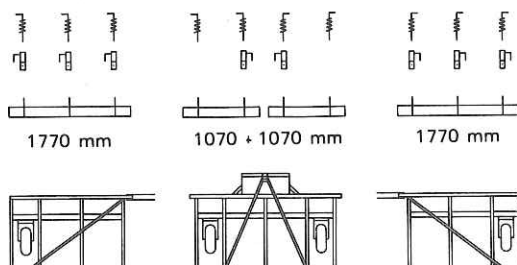

KULTURHARVE
 S - PINNEHARV
 SPRING TINE HARROW
 FEDERZINKENEGGE
 VIBROCULTEUR
 ERPICE COLTIVATORE



SLÆBEPLANKE
 LEVELLING BAR
 PLANIERPLANKE
 PLANCHE NIVELEUSE

2,80 m

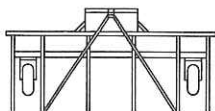
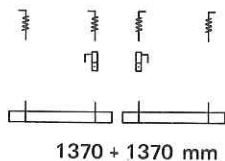

4,00 m

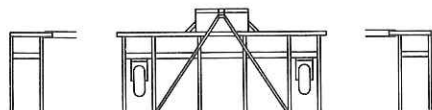
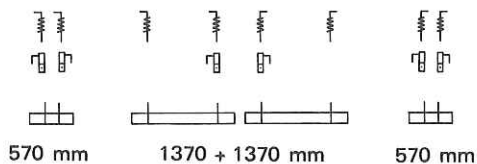

5,20 m

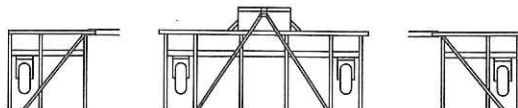
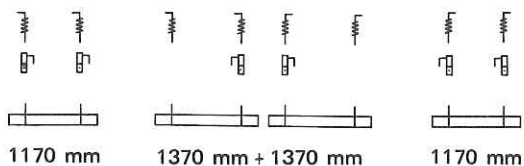

6,40 m

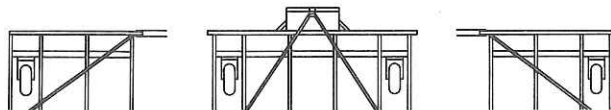
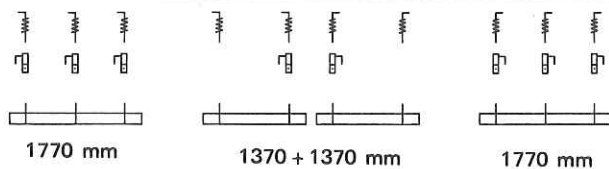

BESPÆNDING
 ASSEMBLY FITTINGS
 BESPANNUNG
 ATTELAGE

Type 1
 Type 1
 Typ 1
 Modelle 1

Type 2
 Type 2
 Typ 2
 Modelle 2

2,20 m

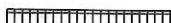
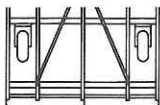

2170 mm

3,40 m

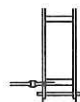
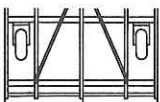

570 mm

2170 mm

570 mm

4,60 m

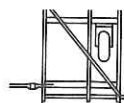
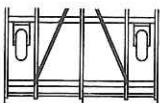
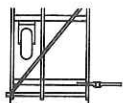

1170 mm

2170 mm

1170 mm

5,80 m

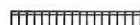
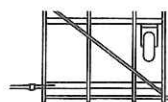
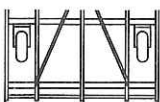
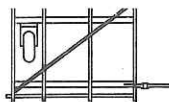

1770 mm

2170 mm

1770 mm

KULTURHARVE
 S - PINNEHARV
 SPRING TINE HARROW
 FEDERZINKENEGGE
 VIBROCOLTEUR
 ERPICE COLTIVATORE



LANGFINGEREFTERHARVE
 LONG - FINGER - HARROW
 ZUSTREICHEGGE
 HERSE ARRIERE A DENTS

2,80 m

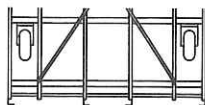

2770 mm

4,00 m

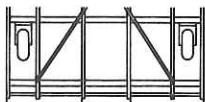

570 mm

2770 mm

570 mm

5,20 m

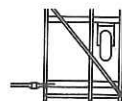
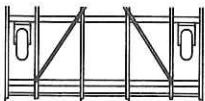
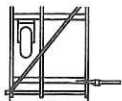

1170 mm

2770 mm

1170 mm

6,40 m

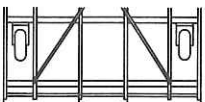
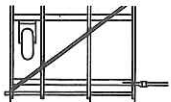

1770 mm

2770 mm

1770 mm

**KOMBI-EFTERHARVE
FINGER / ROLLER COMBINATION
KOMBI-NACHLAÜFER
HERSE ARRIÈRE COMBI**

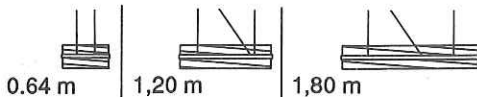

2,20 m

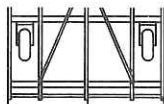

2070 mm

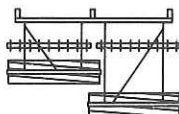

3,40 m



480 mm

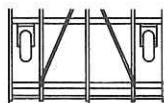

2070 mm



480 mm

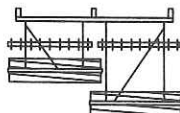

4,60 m

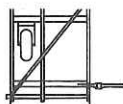

1075 mm

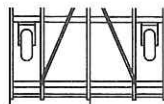

2070 mm

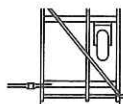

1075 mm

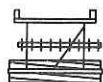
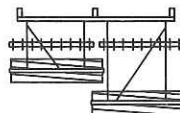
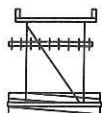

5,80 m

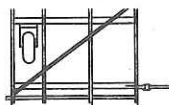

1675 mm

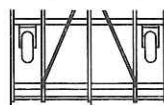

2070 mm

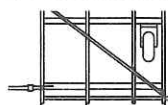

1675 mm

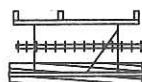
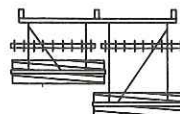
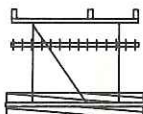

KULTURHARVE
 S - PINNEHARV
 SPRING TINE HARROW
 FEDERZINKENEGGE
 VIBROCOLTEUR
 ERPICE COLTIVATORE



KOMBI-EFTERHARVE
 FINGER / ROLLER COMBINATION
 KOMBI-NACHLAUFER
 HERSE ARRIÈRE COMBI

2,80 m

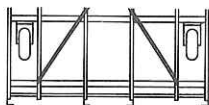

2670 mm

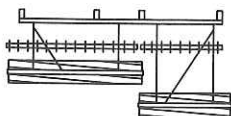

4,00 m



480 mm

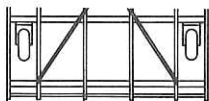

2670 mm



480 mm

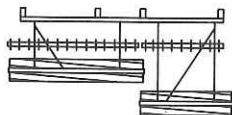

5,20

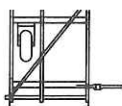

1075 mm

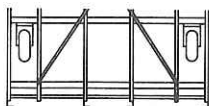

2670 mm

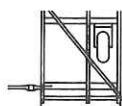

1075 mm

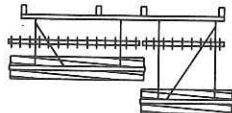
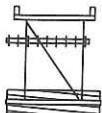

6,40

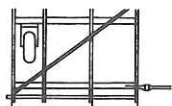

1675 mm

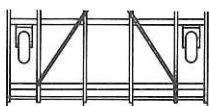

2670 mm

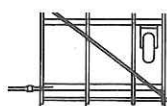

1675 mm

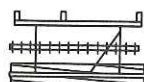
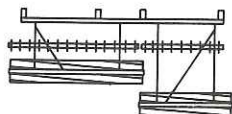
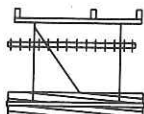

SVENSK

1. Mittsektion och vingar samlas med bultar och naglar.
2. Fjäderstyr A och tryckfjäder B monteras mellan mittsektion och vingar.
3. Hydraulikkolov D monteras med oljetillgång uppåt. Hydraulikslangen C föres upp mellan de två rörstötter.
NB! Cylindrarretet E skall kunna vrider lätt efter montering.
4. Bulten F justeras så att vingen är på linje med mittrammen.

ENGLISH

1. Assemble the centre and side frames using bolts and spikes.
2. Mount spring guide A and compression spring B between the centre and side frames.
3. Mount hydraulic cylinder D with oil access upwards hydraulic hose C is led up between the two braces.
NB: Turn cylinder lock E slightly after assembly.
4. Adjust bolt F so that the side frame is flush with the centre frame.

DEUTSCH

1. Der Tragrahmen und die Seitenfelder werden durch Bolzen und Pflöcke miteinander verbunden.
2. Federsteuerung A und Druckfeder B werden zwischen Tragrahmen und Seitenfeld befestigt.
3. Der Hydraulikkolov D wird mit nach oben weisender Ölzuführung montiert. Der Hydraulikschlauch C wird zwischen den beiden Rohrstreben nach oben geführt.
NB! Die Zylinderarretierung E muß nach dem Montieren leicht gedreht werden.
4. Der Bolzen F wird so eingestellt, daß das Seitenfeld mit dem Tragrahmen fluchtet.

FRANCAIS

1. Assembler le bâti central et les rallonges à l'aide de boulons et de rivets.
2. Monter le guide de ressort A et le ressort de compression B entre le bâti central et la rallonge.
3. Placer le cylindre hydraulique avec l'arrivée d'huile vers le haut. Introduire le tuyau d'hydraulique C entre les deux entretoises tubulaires.
NB! Le verrouillage de cylindre doit pouvoir tourner aisément après montage.
4. Ajuster le boulon F de sorte que la rallonge soit alignée sur le bâti central.

ITALIANO

1. Il telaio centrale e le ali si montano con viti e spine.
2. Il guidamolla A e la molla di compressione B si montano fra il telaio centrale e le ali.
3. Il cilindro idraulico D si monta con l'ingresso olio in alto. Il tubo flessibile C si fa passare fra i due tubi di rinforzo.
NB! L'arresto del cilindro E deve ruotare liberamente dopo il montaggio.
4. Regolare la vite F in modo che le ali siano a livello col telaio centrale.

KULTURHARVE
 S - PINNEHARV
 SPRING TINE HARROW
 FEDERZINKENEGGE
 VIBROCULTEUR
 ERPICE COLTIVATORE

**DOUBLET
 RECORD**

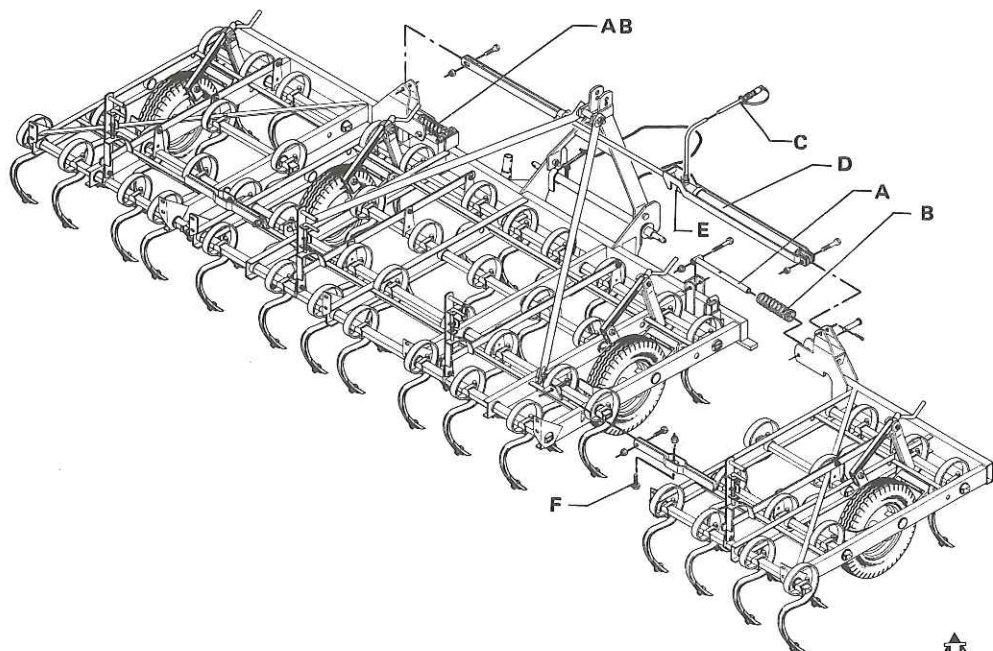

DANSK

1. Midterramme og vinger samles med bolte og nagler.
2. Fjederstyr A og trykfjeder B monteres mellem midterramme og vinge.
3. Hydraulikcylinder D monteres med olietilgang opad. Hydraulikslangen C føres op mellem de to rørstivere.
NB! Cylinderlåsen E skal dreje let efter montering.
4. Bolten F justeres således at vingen flugter med midterrammen.

ENGLISH

1	103-0920	Centre frame, 2.20 m	9	103-0980	Brace, right, 2.,20 m
1	103-1000	Centre frame, 2.80 m	9	103-1060	Brace, right, 2.80 m
2	043-1600	Tension spring, dia. 2 mm	10	101-2230	Three-point-linkage
3	101-2180	Locking pawl, left	11	023-6240	Steel bolt, M20 x 150 mm
4	101-2190	Locking pawl, right	12	023-6110	Steel bolt, M20 x 50 mm
5	101-2170	Rope, L = 4.00 m	13	026-4110	Check nut, M20
6	026-4090	Check nut, M16	14	023-5800	Steel bolt, M16 x 45 mm
7	101-1860	Drawbar, dia. 28 pins	15	037-7400	Hairpin split-pin, dia. 4 mm
8	103-0970	Brace, left, 2.20 m	16	103-0320	Locking spike, dia.10 mm
8	103-1050	Brace, left, 2.80 m	17	103-0290	Support

DEUTSCH

1	103-0920	Tragrahmen, 2,20 m	9	103-0980	Rohrstreben, rechts, 2,20 m
1	103-1000	Tragrahmen, 2,80 m	9	103-1060	Rohrstreben, rechts, 2,80 m
2	043-1600	Zugfeder, ø2 mm	10	101-2230	Dreipunktstativ
3	101-2180	Sperrklinke, links	11	023-6240	Stahlbolzen, M20 x 150 mm
4	101-2190	Sperrklinke, rechts	12	023-6110	Stahlbolzen, M20 x 50 mm
5	101-2170	Tau, L = 4,00 m	13	026-4110	Gegenmutter, M20
6	026-4090	Gegenmutter, M16	14	023-5800	Stahlbolzen, M16 x 45 mm
7	101-1860	Zugwelle, Zapfen ø28 mm	15	037-7400	Haarnadelsplint, ø4 mm
8	103-0970	Rohrstreben, links, 2,20 m	16	103-0320	Bolzen für Stützbein, ø10 mm
8	103-1050	Rohrstreben, links, 2,80 m	17	103-0290	Stützbein

FRANCAIS

1	103-0920	Bâti central, 2,20 m	9	103-0980	Entretoise tubulaire, droite, 2,20 m
1	103-1000	Bâti central, 2,80 m	9	103-1060	Entretoise tubulaire, droite, 2,80 m
2	043-1600	Ressort de tension, ø2 mm	10	101-2230	Potence de 3 ^{ème} point
3	101-2180	Cliquet de verrouillage, gauche	11	023-6240	Boulon acier, M20 x 150 mm
4	101-2190	Cliquet de verrouillage, droit	12	023-6110	Boulon acier, M20 x 50 mm
5	101-2170	Corde, L = 4,00 m	13	026-4110	Ecrou de blocage, M20
6	026-4090	Ecrou de blocage, M16	14	023-5800	Boulon acier, M16 x 45 mm
7	101-1860	Barre d'attelage avec tenon, ø28 mm	15	037-7400	Goupille élastique, ø4 mm
8	103-0970	Entretoise tubulaire, gauche, 2,20 m	16	103-0320	Broche de béquille, ø10 mm
8	103-1050	Entretoise tubulaire, gauche, 2,80 m	17	103-0290	Béquille

KULTURHARVE
S - PINNEHARV
SPRING TINE HARROW
FEDERZINKENEGGE
VIBROCULTEUR
ERPICE COLTIVATORE

**DOUBLET
RECORD**

MIDTERRAMME
CENTER FRAME
TRAGRAHMEN
BATI CENTRAL

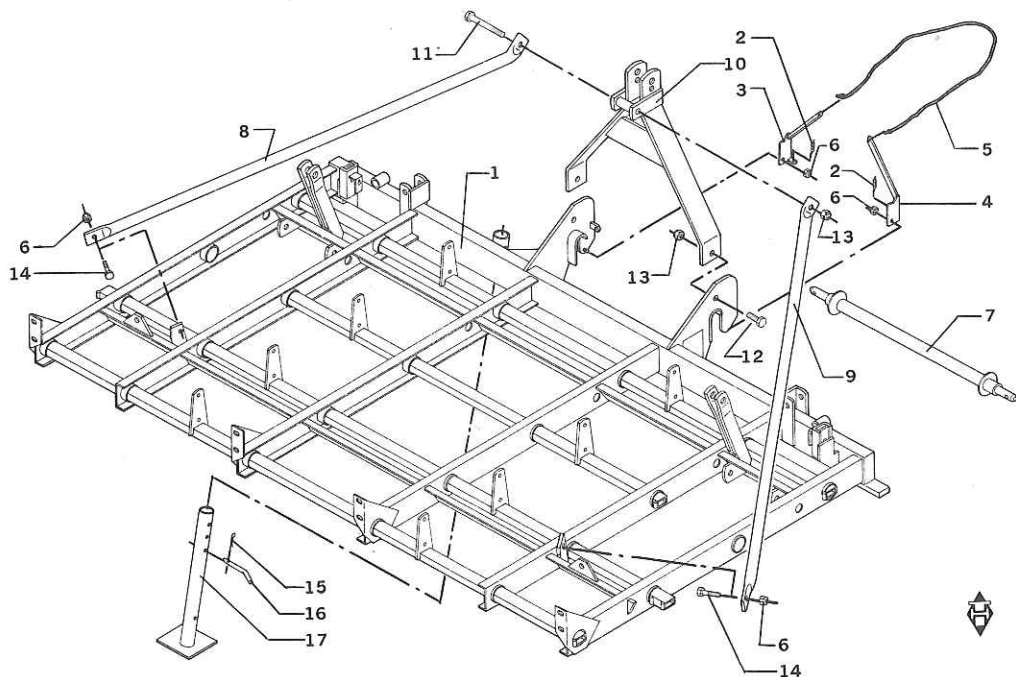

DANSK

1	103-0920	Midterramme, 2,20 m	9	103-0980	Rørstiver, højre, 2,20 m
1	103-1000	Midterramme, 2,80 m	9	103-1060	Rørstiver, højre, 2,80 m
2	043-1600	Trækfjeder, ø2 mm	10	101-2230	Topgalge
3	101-2180	Låsepal, venstre	11	023-6240	Stålbolt, M20 x 150 mm
4	101-2190	Låsepal, højre	12	023-6110	Stålbolt, M20 x 50 mm
5	101-2170	Rebstykke, L = 4,00 m	13	026-4110	Låsemøtrik, M20
6	026-4090	Låsemøtrik, M16	14	023-5800	Stålbolt, M16 x 45 mm
7	101-1860	Trækbom, ø28 tappe	15	037-7400	Hårnålesplit, ø4 mm
8	103-0970	Rørstiver, venstre, 2,20 m	16	103-0320	Nagle for støtteben, ø10 mm
8	103-1050	Rørstiver, venstre, 2,80 m	17	103-0290	Støtteben

ENGLISH

1	103-0470	Side frame, 0.60 m, left	6	103-0250	Spring guide
1	103-0540	Side frame, 1.20 m, left	7	023-6190	Steel bolt, M20 x 100 mm
1	103-0630	Side frame, 1.80 m, left	8	026-4110	Check nut, M20
2	103-0480	Side frame, 0.60 m, right	9	103-0280	Spike for side frame, dia. 16 x 155 mm
2	103-0550	Side frame, 1.20 m, right	10	037-7400	Hairpin split-pin, dia. 4 mm
2	103-0640	Side frame, 1.80 m, right	11	026-1410	Steel nut, M20
3	101-1570	Spike, dia. 25 x 100 mm	12	023-6140	Steel bolt, M20 x 65 mm
4	037-3450	Split-pin, dia. 6 x 50 mm	13	023-6110	Steel bolt, M20 x 50 mm
5	037-7600	Hairpin split-pin, dia. 6 mm (0.60 m side frame only)			

DEUTSCH

1	103-0470	Seitenfeld, 0,60 m, links	6	103-0250	Federsteuerung
1	103-0540	Seitenfeld, 1,20 m, links	7	023-6190	Stahlbolzen, M20 x 100 mm
1	103-0630	Seitenfeld, 1,80 m, links	8	026-4110	Gegenmutter, M20
2	103-0480	Seitenfeld, 0,60 m, rechts	9	103-0280	Bolzen für Seitenfeld, ø16 x 155 mm
2	103-0550	Seitenfeld, 1,20 m, rechts	10	037-7400	Haarnadelsplint, ø4 mm
2	103-0640	Seitenfeld, 1,80 m, rechts	11	026-1410	Stahlmutter, M20
3	101-1570	Bolzen, ø25 x 100 mm	12	023-6140	Stahlbolzen, M20 x 65 mm
4	037-3450	Splint, ø6 x 50 mm	13	023-6110	Stahlbolzen, M20 x 50 mm
5	037-7600	Haarnadelsplint, ø6 mm (nur 0,60 m Seitenfeld)			

FRANCAIS

1	103-0470	Rallonge, 0,60 m, gauche	6	103-0250	Guide de ressort
1	103-0540	Rallonge, 1,20 m, gauche	7	023-6190	Boulon acier, M20 x 100 mm
1	103-0630	Rallonge, 1,80 m, gauche	8	026-4110	Ecrou de blocage, M20
2	103-0480	Rallonge, 0,60 m, droite	9	103-0280	Broché de rallonge, ø16 x 155 mm
2	103-0550	Rallonge, 1,20 m, droite	10	037-7400	Goupille élastique, ø4 mm
2	103-0640	Rallonge, 1,80 m, droite	11	026-1410	Ecrou acier, M20
3	101-1570	Broché, ø25 x 100 mm	12	023-6140	Boulon acier, M20 x 65 mm
4	037-3450	Clavette fendue, ø6 x 50 mm	13	023-6110	Boulon acier, M20 x 50 mm
5	037-7600	Goupille élastique, ø6 mm (rallonge de 0,60 m seulem.)			

KULTURHARVE
S - PINNEHARV
SPRING TINE HARROW
FEDERZINKENEGGE
VIBROCULTEUR
ERPICE COLTIVATORE

**DOUBLET
RECORD**

VINGE
SIDE FRAME
SEITENFELD
RALLONGE

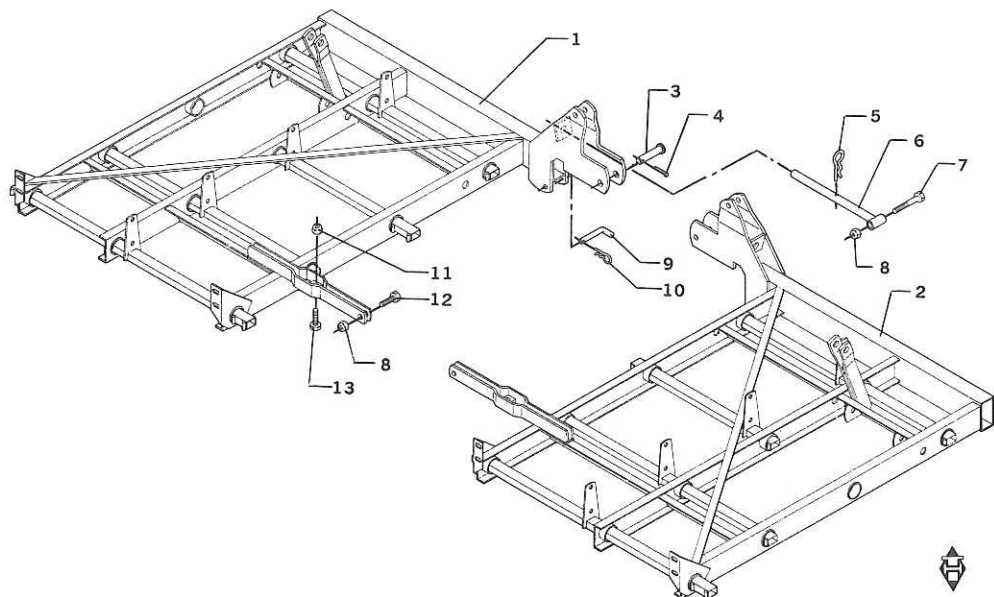

DANSK

1	103-0470	Vinge, 0,60 m, venstre	6	103-0250	Fjederstyr
1	103-0540	Vinge, 1,20 m, venstre	7	023-6190	Stålbolt, M20 x 100 mm
1	103-0630	Vinge, 1,80 m, venstre	8	026-4110	Låsemøtrik, M20
2	103-0480	Vinge, 0,60 m, højre	9	103-0280	Nagle f. vinge, $\varnothing 16 \times 155$ mm
2	103-0550	Vinge, 1,20 m, højre	10	037-7400	Hårnålesplit, $\varnothing 4$ mm
2	103-0640	Vinge, 1,80 m, højre	11	026-1410	Stålmøtrik, M20
3	101-1570	Nagle, $\varnothing 25 \times 100$ mm	12	023-6140	Stålbolt, M20 x 65 mm
4	037-3450	Split, $\varnothing 6 \times 50$ mm	13	023-6110	Stålbolt, M20 x 50 mm
5	037-7600	Hårnålesplit, $\varnothing 6$ mm (kun 0,60 m vinge)			

ENGLISH

1	042-2020	Reversible tine, K24	10	027-2270	Facet disk, dia. 12 mm
2	038-6210	Row bolt, M10 x 40 mm, with nut	11	103-0380	Locking pawl, dia. 16 x 280 mm
3	042-2000	Spring tine harrow tine, BK24 (incl. pos. 1 - 2)	12	037-1540	Retaining pin, dia. 6 x 50 mm
4	026-4070	Check nut, M12	13	043-1120	Compression spring, dia. 2 x 85 mm
5	103-3460	?????	14	103-0340	Adjusting lever
6	023-5410	Steel bolt, M12 x 65 mm	15	103-0330	Adjusting lever, complete (pos. 11 - 14)
7	091-0350	Spring tine harrow tine, complete (pos. 3 - 6)	16	101-2000	Spacing buch, dia. 18/13 x 13 mm
8	023-5360	Steel bolt, M12 x 40 mm	17	103-0390	Connecting rod
9	023-5380	Steel bolt, M12 x 50 mm			

DEUTSCH

1	042-2020	Zinkenzpitze, K24	9	023-5380	Stahlbolzen, M12 x 50 mm
2	038-6210	Bolzen, M10 x 40 mm, mit Mutter	10	027-2270	Facettenscheibe, ø12 mm
3	042-2000	Federzinken, BK24 (mit Pos. 1 - 2)	11	103-0380	Sperrklinke, ø16 x 280 mm
4	026-4070	Gegenmutter, M12	12	037-1540	Spannstift, ø6 x 50 mm
5	103-3460	?????	13	043-1120	Druckfeder, ø2 x 85 mm
6	023-5410	Stahlbolzen, M12 x 65 mm	14	103-0340	Einstellhebel
7	091-0350	Federzinken, komplett (Pos. 3 - 6)	15	103-0330	Einstellhebel, komplett (Pos. 11 - 14)
8	023-5360	Stahlbolzen, M12 x 40 mm	16	101-2000	Distanzbuchse, ø18/13 x 13 mm
			17	103-0390	Verbindungsstange

FRANCAIS

1	042-2020	Pointe de dent, K24	11	103-0380	Cliquet de verrouillage, ø16 x 280 mm
2	038-6210	Boulon, M10 x 40 mm, avec écrou	12	037-1540	Goupille de tension, ø6 x 50 mm
3	042-2000	Dent de vibroculteur, BK24 (pos. 1 - 2 compr.)	13	043-1120	Ressort de pression, ø2 x 85 mm
4	026-4070	Ecrou de blocage, M12	14	103-0340	Manette de réglage
5	103-3460	?????	15	103-0330	Manette de réglage, compl. (pos. 11 - 14)
6	023-5410	Boulon acier, M12 x 65 mm	16	101-2000	Douille d'écartement, ø18/13 x 13 mm
7	091-0350	Dent de vibroculteur, compl. (pos. 3 - 6)	17	103-0390	Tige d'assemblage
8	023-5360	Boulon acier, M12 x 40 mm			
9	023-5380	Boulon acier, M12 x 50 mm			
10	027-2270	Rondelle biseautée, ø12 mm			

KULTURHARVE
S - PINNEHARV
SPRING TINE HARROW
FEDERZINKENEGGE
VIBROCULTEUR
ERPICE COLTIVATORE

**DOUBLET
RECORD**

STILLEHÅNDTAG
ADJUSTING LEVER
EINSTELLHEBEL
MANETTE DE REGLAGE

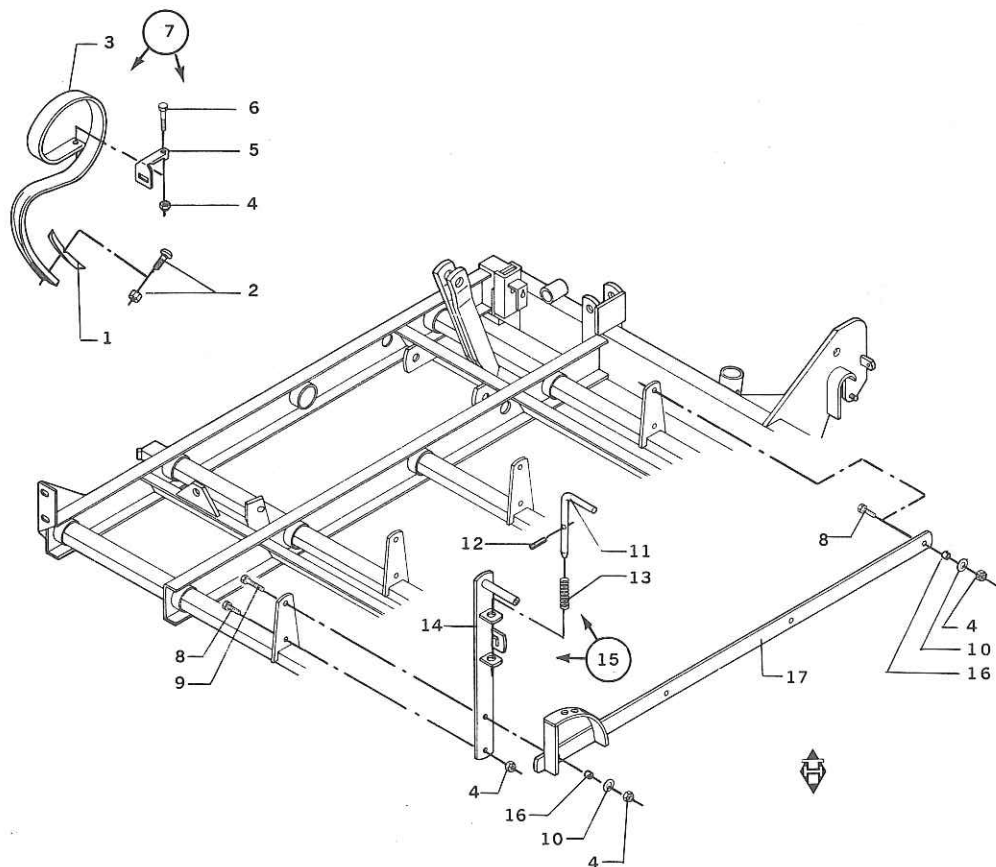

DANSK

1	042-2020	Tandspids, K24	9	023-5380	Stålbolt, M12 x 50 mm
2	038-6210	Radrenserbolt, M10 x 40 mm, med møtrik	10	027-2270	Facetskive, ø12 mm
3	042-2000	Kulturharvetand, BK24 (incl. pos. 1 - 2)	11	103-0380	Låsepal, ø16 x 280 mm
4	026-4070	Låsemøtrik, M12	12	037-1540	Spændstift, ø6 x 50 mm
5	103-3460	Tandholder, type 10	13	043-1120	Trykfeder, ø2 x 85 mm
6	023-5410	Stålbolt, M12 x 65 mm	14	103-0340	Stillehåndtag
7	091-0350	Komplet kulturharvetand (pos. 3 - 6)	15	103-0330	Stillehåndtag, komplet (pos. 11 - 14)
8	023-5360	Stålbolt, M12 x 40 mm	16	101-2000	Åfstandsøsning, ø18/13 x 13 mm
			17	103-0390	Forbindelsesstang

ENGLISH

1	039-5700	Rubber wheel, complete (pos. 2 - 12)	13	103-0110	Wheel fork, left
2	039-5710	Rim (incl. pos. 3 - 10)	14	101-2290	Scraper
3	039-5740	Spacer	15	027-1570	Disk, dia. 16 mm
4	039-5750	Shaft	16	024-2750	Machine bolt, M16 x 230
5	047-2950	Ball bearing, 6205	17	026-4090	Check nut, M16
6	039-5760	Sealing disk	18	101-2300	Spindle nut
7	039-5730	Felt ring	19	103-0210	Spindle, L = 425 mm
8	039-5770	Sealing ring	20	103-0230	Guide, L = 380 mm
9	039-5772	Spacer	21	037-1500	Retaining pin, dia. 6 x 32 mm
10	043-2100	Lubricating nipple	22	101-1420	Crank
11	039-5780	Tube	23	101-1470	Bearing
12	039-5790	Tyre, 600 x 12 - 4 ply	24	103-0200	Shaft for wheel fork, dia. 19 x 275 mm
13	103-0120	Wheel fork, right	25	037-3350	Split-pin, dia. 5 x 50 mm

DEUTSCH

1	039-5700	Gummirad, komplett (Pos. 2 - 12)	13	103-0110	Radgabel, links
2	039-5710	Felge (einschl. Pos. 3 - 10)	14	101-2290	Abstreicher
3	039-5740	Distanzrohr	15	027-1570	Scheibe, ø16 mm
4	039-5750	Rphrwelle	16	024-2750	Bolzen, M16 x 230
5	047-2950	Kugellager, 6205	17	026-4090	Gegenmutter, M16
6	039-5760	Dichtungsring	18	101-2300	Spindelmutter
7	039-5730	Filzring	19	103-0210	Spindel, L = 425 mm
8	039-5770	Dichtring	20	103-0230	Lineal, L = 380 mm
9	039-5772	Distanzrohr	21	037-1500	Spannstift, ø6 x 32 mm
10	043-2100	Schmiernippel	22	101-1420	Handkurbel
11	039-5780	Schlauch	23	101-1470	Lager
12	039-5790	Reifen, 600 x 12 - 4 fach	24	103-0200	Welle für Radgabel, ø19 x 275 mm
13	103-0120	Radgabel, rechts	25	037-3350	Splint, ø5 x 50 mm

FRANCAIS

1	039-5700	Roue en caoutchouc, compl. (pos. 2 - 12)	14	101-2290	Racloir
2	039-5710	Jante (pos. 3 - 10 incl.)	15	027-1570	Rondelle, ø16 mm
3	039-5740	Tube de distance	16	024-2750	Boulon, M16 x 230
4	039-5750	Arbre creux	17	026-4090	Ecrou de blocage, M16
5	047-2950	Roulement à billes, 6205	18	101-2300	Ecrou de broche
6	039-5760	Rondelle d'étanchéité	19	103-0210	Broche, L = 425 mm
7	039-5730	Rondelle de feutre	20	103-0230	Règle, L = 380 mm
8	039-5770	Rondelle d'étanchéité	21	037-1500	Goupille de tension, ø6 x 32 mm
9	039-5772	Tube de distance	22	101-1420	Manivelle à main
10	043-2100	Nipple de graissage	23	101-1470	Coussinet
11	039-5780	Tuyau	24	103-0200	Arbre de support de roue, ø19 x 275 mm
12	039-5790	Pneu, 600 x 12 - 4 plis	25	037-3350	Clavette fendue, ø5 x 50 mm
13	103-0120	Support de roue, droit			
13	103-0110	Support de roue, gauche			

KULTURHARVE
S - PINNEHARV
SPRING TINE HARROW
FEDERZINKENEGGE
VIBROCULTEUR
ERPICE COLTIVATORE



HJULOPHÆNG
WHEEL SUSPENSION
RADAUFHÄNGUNG
SUSPENSION DES RUES

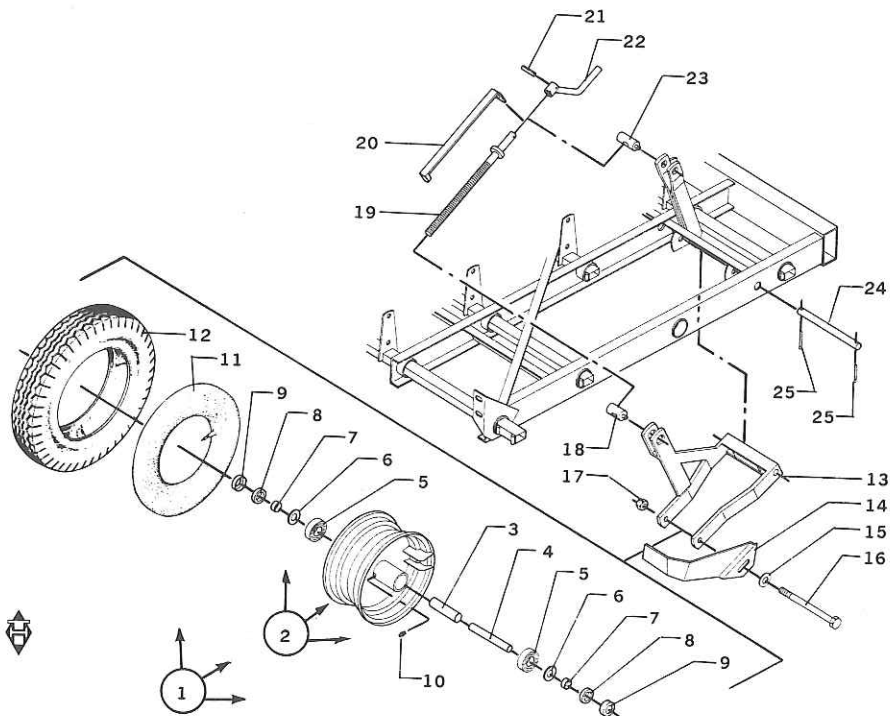

DANSK

1	039-5700	Gummihjul, komplet (pos. 2 - 12)	13	103-0110	Hjulgaffel, venstre
2	039-5710	Fælg (incl. pos. 3 - 10)	14	101-2290	Skraber
3	039-5740	Afstandsør	15	027-1570	Skive, $\varnothing 16$ mm
4	039-5750	Røraksel	16	024-2750	Maskinbolt, M16 x 230
5	047-2950	Kugleleje, 6205	17	026-4090	Låsemøtrik, M16
6	039-5760	Tætnings-skive	18	101-2300	Spindelmøtrik
7	039-5730	Filtring	19	103-0210	Spindel, L = 425 mm
8	039-5770	Tætningsring	20	103-0230	Lineal, L = 380 mm
9	039-5772	Afstandsør	21	037-1500	Spændstift, $\varnothing 6$ x 32 mm
10	043-2100	Smørenippel	22	101-1420	Håndsving
11	039-5780	Slange	23	101-1470	Leje
12	039-5790	Dæk, 600 x 12 - 4 lags	24	103-0200	Aksel for hjulgaffel, $\varnothing 19$ x 275 mm
13	103-0120	Hjulgaffel, højre	25	037-3350	Split, $\varnothing 5$ x 50 mm

ENGLISH

1	044-9020	Dust cap	18	046-2091	Stuffing box
2	044-4020	Quick-coupling, 1/2" - male	19	- -	Sleeve
3	- -	Bushing	20	- -	Scraper ring
4	045-4450	Hydraulic hose, L = 1.50 m	21	037-9820	Spring ring
5	023-4770	Steel bolt, M8 x 30 mm	22	037-9180	Locking ring
6	103-1500	Support pawl	23	046-2121	Piston rod
7	026-4050	Check nut, M8	24	046-2070	Stuffing set, complete (pos. 12 - 15 - 16 - 17 - 19 - 20)
8	103-1510	Cylinder lock	25	046-2101	Cylinder, comp. (pos. 11 - 23)
9	023-6190	Steel bolt, M20 x 100 mm	26	103-1600	Tension nut, long, for 2.80 m centre frame
10	026-4110	Check nut, M20	26	103-1580	Tension nut, short, for 2.20 m centre frame
11	046-2131	Cylinder drum	27	023-6170	Steel bolt, M20 x 80 mm
12	- -	O-ring	28	043-1430	Compression spring, dia. 12 x 240 mm
13	037-9550	Spring ring	29	037-1540	Retaining pin, dia. 6 x 50 mm
14	046-2051	Piston			
15	- -	Sleeve			
16	- -	O-ring			
17	- -	O-ring			

DEUTSCH

1	044-9020	Staubkappe	17	- -	O-Ring
2	044-4020	Schnellkupplung, 1/2" - Stecker	18	046-2091	Stopfbuchse
3	- -	Nippelmuffe	19	- -	Manschette
4	045-4450	Hydraulischlauch, L = 1,50 m	20	- -	Abstreichring
5	023-4770	Stahlbolzen, M8 x 30 mm	21	037-9820	Springring
6	103-1500	Stützklinke	22	037-9180	Schliessring
7	026-4050	Gegenmutter, M8	23	046-2121	Kolbenstange
8	103-1510	Zylinderarretierung	24	046-2070	Dichtungssatz (Pos. 12 - 15 - 16 - 17 - 19 - 20)
9	023-6190	Stahlbolzen, M20 x 100 mm	25	046-2101	Zylinder, komp. (Pos. 11 - 23)
10	026-4110	Gegenmutter, M20	26	103-1600	Zugmutter, lang für Tragrahmen, 2,80 m
11	046-2131	Zylinderrohr	26	103-1580	Zugmutter, kurz für Tragrahmen, 2,20 m
12	- -	O-Ring	27	023-6170	Stahlbolzen, M20 x 80 mm
13	037-9550	Springring	28	043-1430	Druckfeder, ø12 x 240 mm
14	046-2051	Kolben	29	037-1540	Spannstift, ø6 x 50 mm
15	- -	Manschette			
16	- -	O-Ring			

FRANCAIS

1	044-9020	Capuchon anti-poussière	17	- -	Segment en O
2	044-4020	Tuyau d'attelage automatique, 1/2" - male	18	046-2091	Presse-garniture
3	- -	Manchon de raccord fileté	19	- -	Manchon
4	045-4450	Tuyau d'hydraulique, L = 1,50 m	20	- -	Segment racléut
5	023-4770	Ecrou acier, M8 x 30 mm	21	037-9820	Rondelle élastique
6	103-1500	Cliquet de support	22	037-9180	Colier de serrage
7	026-4050	Ecrou de blocage, M8	23	046-2121	Tige de piston
8	103-1510	Verrouillage de vérin	24	046-2070	Jeu de garnitures (pos. 12 - 15 - 16 - 17 - 19 - 20)
9	023-6190	Boulon acier, M20 x 100 mm	25	046-2101	Vérin, compl. (pos. 11 - 23)
10	026-4110	Ecrou de blocage, M20	26	103-1600	Barre de traction, "Longue" pour bâti central, 2,80 m
11	046-2131	Chemise de vérin	26	103-1580	Barre de traction, "Courte" pour bâti central, 2,20 m
12	- -	Segment en O	27	023-6170	Boulon acier, M20 x 80 mm
13	037-9550	Rondelle élastique	28	043-1430	Ressort de pression, ø12 x 240 mm
14	046-2051	Piston	29	037-1540	Goupille de tension, ø6 x 50 mm
15	- -	Manchon			
16	- -	Segment en O			

KULTURHARVE
S - PINNEHARV
SPRING TINE HARROW
FEDERZINKENEGGE
VIBROCULTEUR
ERPICE COLTIVATORE



HYDRAULIKUDSTYR
HYDRAULIC EQUIPMENT
HYDRAULISCHE AUSRÜSTUNG
EQUIPMENT HYDRAULIQUE

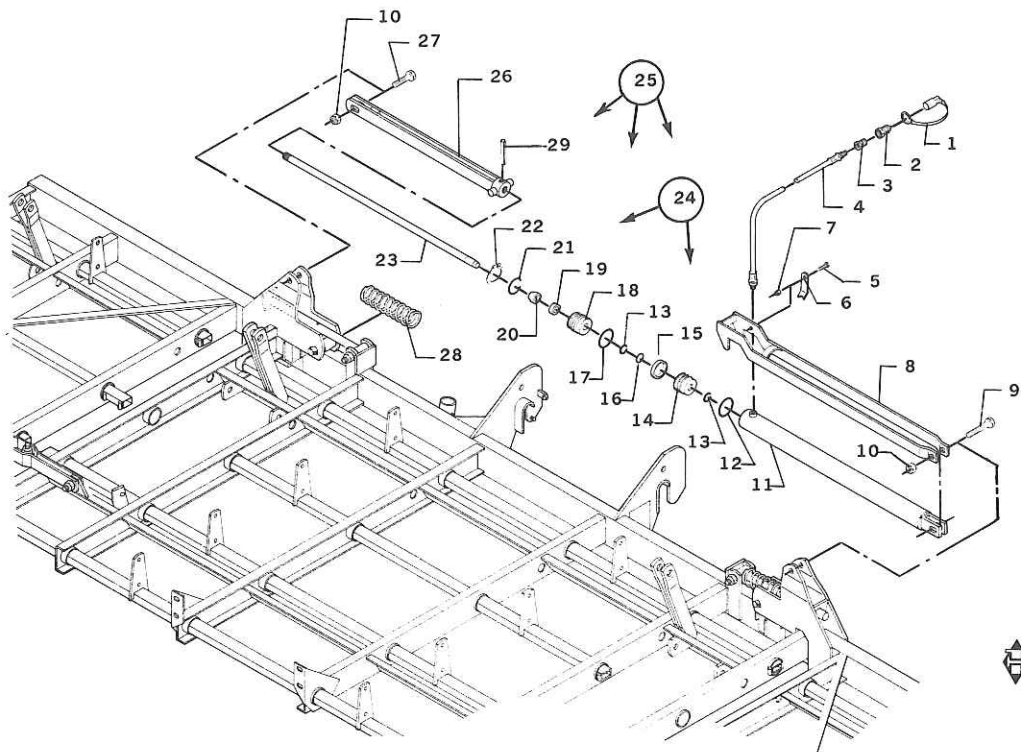

DANSK

1	044-9020	Støvhætte	18	046-2091	Pakdåse
2	044-4020	Lynkobling, 1/2" - han	19	- - -	Manchet
3	- - -	Nippelmuffe	20	- - -	Skrabereng
4	045-4450	Hydraulikslange, L = 1,50 m	21	037-9820	Springring
5	023-4770	Stålbolt, M8 x 30 mm	22	037-9180	Låsering
6	103-1500	Støttepal	23	046-2121	Stempelstang
7	026-4050	Låsemøtrik, M8	24	046-2070	Pakningssæt (pos. 12 - 15 - 16 - 17 - 19 - 20)
8	103-1510	Cylinderlås	25	046-2101	Cylinder, komplet (pos. 11 - 23)
9	023-6190	Stålbolt, M20 x 100 mm	26	103-1600	Trækmøtrik, lang, til 2,80 m midterramme
10	026-4110	Låsemøtrik, M20	26	103-1580	Trækmøtrik, kort, til 2,20 m midterramme
11	046-2131	Cylinderrør	27	023-6170	Stålbolt, M20 x 80 mm
12	- - -	O-ring	28	043-1430	Trykfjeder, ø12 x 240 mm
13	037-9550	Springring	29	037-1540	Spændstift, ø6 x 50 mm
14	046-2051	Stempel			
15	- - -	Manchet			
16	- - -	O-ring			
17	- - -	O-ring			

ENGLISH

1	103-1830	Levelling bar f. 0.60 m (570 mm)	10	103-1740	Lever
1	103-1850	Levelling bar f. 1.20 m (1170 mm)	11	023-5350	Steel bolt, M12 x 35 mm
1	103-1870	Levelling bar f. 1.80 m (1770 mm)	12	103-1750	Spring holder
1	103-1890	Levelling bar f. 2.20 m (1070 mm)	13	103-1810	Adjusting fittings, complete, left (pos. 6 - 12)
1	103-1910	Levelling bar f. 2.80 m (1370 mm)	13	103-1820	Adjusting fittings, complete, right (pos. 6 - 12)
2	037-3310	Split-pin, dia. 5 x 32 mm	14	103-1700	Retaining plate
3	101-1520	Spike, 1/2" x 50 mm	15	026-4070	Check nut, M12
4	027-2270	Facet disk, dia. 12 mm	16	023-5460	Steel bolt, M12 x 100 mm
5	101-2800	Spacing bush, dia. 18/13 x 13 mm	17	103-1660	Assembly fittings, Type 1
6	103-1640	Locking pawl, dia. 16 mm	17	103-1670	Assembly fittings, Type 2
7	037-1350	Retaining pin, dia. 5 x 22 mm	18	103-1770	Assembly fittings, Type 1,
8	103-1710	Adjusting piece			
9	043-1260	Compression spring, dia. 6 x 230 mm			

DEUTSCH

1	103-1830	Planierplanke f. 0,60 m (570 mm)	12	103-1750	Federhalterung
1	103-1850	Planierplanke f. 1,20 m (1170 mm)	13	103-1810	Einstellbeschlag, komplett, links (Pos. 6 - 12)
1	103-1870	Planierplanke f. 1,80 m (1770 mm)	13	103-1820	Einstellbeschlag, komplett, rechts (Pos. 6 - 12)
1	103-1890	Planierplanke f. 2,20 m (1070 mm)	14	103-1700	Spannplatte
1	103-1910	Planierplanke f. 2,80 m (1370 mm)	15	026-4070	Gegenmutter, M12
2	037-3310	Splint, ø5 x 32 mm	16	023-5460	Stahlbolzen, M12 x 100 mm
3	101-1520	Bolzen, 1/2" x 50 mm	17	103-1660	Bespannung, Typ 1
4	027-2270	Facettenscheibe, ø12 mm	17	103-1670	Bespannung, Typ 2
5	101-2800	Distanzbuchse, ø18/13 x 13 mm	18	103-1770	Bespannung, komplett, Typ 1 (Pos. 14 - 17)
6	103-1640	Sperrklinke, ø16 mm	18	103-1780	Bespannung, komplett, Typ 2 (Pos. 14 - 17)
7	037-1350	Spannstift, ø5 x 22 mm			
8	103-1710	Einstellbeschlag			
9	043-1260	Druckfeder, ø6 x 230 mm			
10	103-1740	Griff			
11	023-5350	Stahlbolzen, M12 x 35 mm			

FRANCAIS

1	103-1830	Élément Planche niveleuse 0,60 m (570 mm)	9	043-1260	Ressort de pression, ø6 x 230 mm
1	103-1850	Élément Planche niveleuse 1,20 m (1170 mm)	10	103-1740	Manette
1	103-1870	Élément Planche niveleuse 1,80 m (1770 mm)	11	023-5350	Boulon acier, M12 x 35 mm
1	103-1890	Élément Planche niveleuse 2,20 m (1070 mm)	12	103-1750	Vis de fermeture
1	103-1910	Élément Planche niveleuse 2,80 m (1370 mm)	13	103-1810	Garniture de réglage, compl., gauche (pos. 6 - 12)
2	037-3310	Clavette fendue, ø5 x 32 mm	13	103-1820	Garniture de réglage, compl., droite (pos. 6 - 12)
3	101-1520	Rivet, 1/2" x 50 mm	14	103-1700	Plateau de serrage
4	027-2270	Rondelle biseautée, ø12 mm	15	026-4070	Ecrou de blocage, M12
5	101-2800	Douille d'écartement, ø18/13 x 13 mm	16	023-5460	Boulon acier, M12 x 100 mm
6	103-1640	Cliquet de verrouillage, ø16 mm	17	103-1660	Attelage, modèle 1
7	037-1350	Goupille de tension, ø5 x 22 mm	17	103-1670	Attelage, modèle 2
8	103-1710	Pièce de réglage	18	103-1770	Attelage, compl. (pos. 14 - 17) modèle 1
			18	103-1780	Attelage, compl. (pos. 14 - 17) modèle 2

KULTURHARVE
S - PINNEHARV
SPRING TINE HARROW
FEDERZINKENEGGE
VIBROCOLTEUR
ERPICE COLTIVATORE



SLÆBEPLANKE
LEVELLING BAR
PLANIERPLANKE
PLANCHE NIVELEUSE

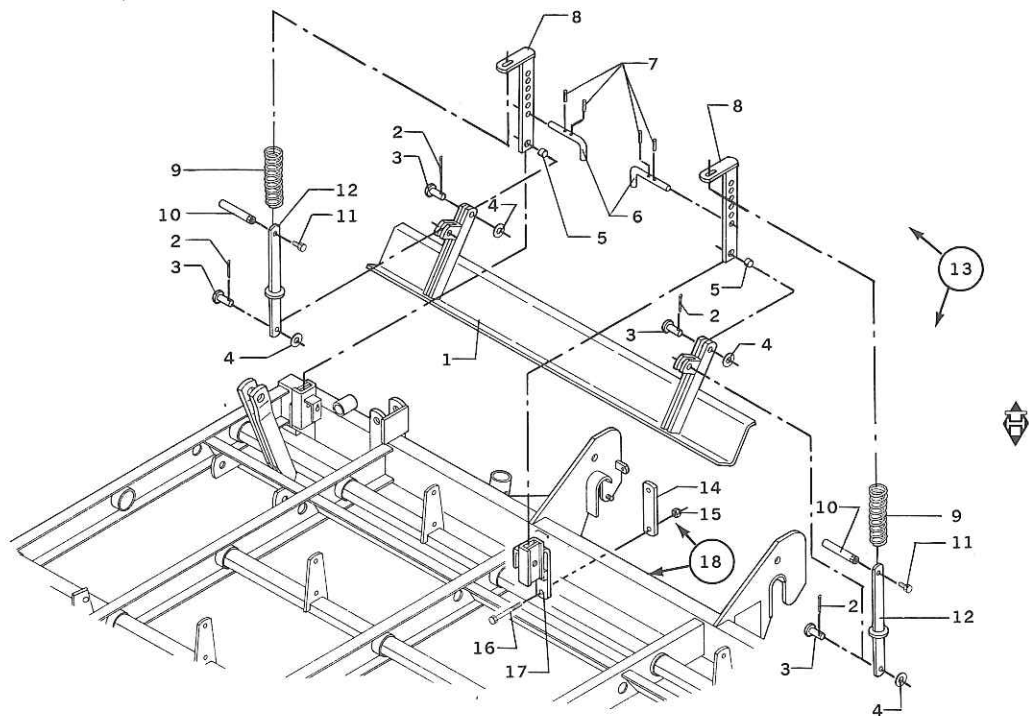

DANSK

1	103-1830	Slæbeplanke t. 0,60 m (570 mm)	12	103-1750	Fjederholder
1	103-1850	Slæbeplanke t. 1,20 m (1170 mm)	13	103-1810	Komplet reguleringsbeslag, venstre (pos. 6 - 12)
1	103-1870	Slæbeplanke t. 1,80 m (1770 mm)	13	103-1820	Komplet reguleringsbeslag, højre (pos. 6 - 12)
1	103-1890	Slæbeplanke t. 2,20 m (1070 mm)	14	103-1700	Spændeplade
1	103-1910	Slæbeplanke t. 2,80 m (1370 mm)	15	026-4070	Låsemøtrik, M12
2	037-3310	Split, $\varnothing 5 \times 32$ mm	16	023-5460	Stålbolt, M12 x 100 mm
3	101-1520	Nagle, $1/2'' \times 50$ mm	17	103-1660	Bespænding, Type 1
4	027-2270	Facetskive, $\varnothing 12$ mm	17	103-1670	Bespænding, Type 2
5	101-2800	Afstandsøsning, $\varnothing 18/13 \times 13$ mm	18	103-1770	Komplet bespænding, Type 1 (pos. 14 - 17)
6	103-1640	Låsepæl, $\varnothing 16$ mm	18	103-1780	Komplet bespænding, Type 2 (pos. 14 - 17)
7	037-1350	Spændestift, $\varnothing 5 \times 22$ mm			
8	103-1710	Reguleringsstykke			
9	043-1260	Trykfjeder, $\varnothing 6 \times 230$ mm			
10	103-1740	Håndtag			
11	023-5350	Stålbolt, M12 x 35 mm			

ENGLISH

1	103-2850	Bar for 0.60 m (570 mm)	12	101-1580	Spike, dia. 13 mm
1	103-2870	Bar for 1.20 m (1170 mm)	13	101-2570	Draw arm
1	103-2890	Bar for 1.80 m (1770 mm)	14	103-2770	Spring guide
1	103-2910	Bar for 2.20 m (2170 mm)	15	037-3750	Split-pin, dia. 10 x 60 mm
1	103-2950	Bar for 2.80 m (2770 mm)	16	043-1250	Compression spring, dia. 6 x 180 mm
2	038-2100	Clamp, M10	17	027-2350	Facet disk, dia. 30 mm
3	042-6100	Long finger tine, dia. 10 mm	18	023-5800	Steel bolt, M16 x 45 mm
4	101-2510	Retaining plate, M10	19	026-4090	Check nut, M16
5	026-4060	Check nut, M10	20	023-5350	Steel bolt, M12 x 35 mm
6	091-0500	Long finger tine, complete (pos. 2 - 5)	21	027-2270	Facet disk, dia. 12 mm
7	038-2120	Clamp, M12	22	103-2730	Bolting support, Type 1
8	101-2590	Holed bracket	22	103-2740	Bolting support, Type 2
9	026-4070	Check nut, M12	23	103-2810	Assembly fittings, Type 1, complete (pos. 7 - 22)
10	023-5360	Steel bolt, M12 x 40 mm	23	103-2820	Assembly fittings, Type 2, complete (pos. 7 - 22)
11	037-7400	Hairpin split-pin, dia. 4 mm			

DEUTSCH

1	103-2850	Rahmen f. 0,60 m (570 mm)	12	101-1580	Bolzen, ø13 mm
1	103-2870	Rahmen f. 1,20 m (1170 mm)	13	101-2570	Zugarm
1	103-2890	Rahmen f. 1,80 m (1770 mm)	14	103-2770	Federsteuerung
1	103-2910	Rahmen f. 2,20 m (2170 mm)	15	037-3750	Splint, ø10 x 60 mm
1	103-2950	Rahmen f. 2,80 m (2770 mm)	16	043-1250	Druckfeder, ø6 x 180 mm
2	038-2100	Klammer, M10	17	027-2350	Facettenscheibe, ø30 mm
3	042-6100	Zustreichzinken, ø10 mm	18	023-5800	Stahlbolzen, M16 x 45 mm
4	101-2510	Spannplatte, M10	19	026-4090	Gegenmutter, M16
5	026-4060	Gegenmutter, M10	20	023-5350	Stahlbolzen, M12 x 35 mm
6	091-0500	Zustreichzinken, komplett (Pos. 2 - 5)	21	027-2270	Facettenscheibe, ø12 mm
7	038-2120	Klammer, M12	22	103-2730	Aufbolzstück, Typ 1
8	101-2590	Hohlbogen	22	103-2740	Aufbolzstück, Typ 2
9	026-4070	Gegenmutter, M12	23	103-2810	Bespannung, komplett, Typ 1 (Pos. 7 - 22)
10	023-5360	Stahlbolzen, M12 x 40 mm	23	103-2820	Bespannung, komplett, Typ 2 (Pos. 7 - 22)
11	037-7400	Haarnadelsplint, ø4 mm			

FRANCAIS

1	103-2850	Barre 0,60 m (570 mm)	14	103-2770	Guide de ressort
1	103-2870	Barre 1,20 m (1170 mm)	15	037-3750	Clavette fendue, ø10 x 60 mm
1	103-2890	Barre 1,80 m (1770 mm)	16	043-1250	Ressort de pression, ø6 x 180 mm
1	103-2910	Barre 2,20 m (2170 mm)	17	027-2350	Rondelle biseautée, ø30 mm
1	103-2950	Barre 2,80 m (2770 mm)	18	023-5800	Boulon acier, M16 x 45 mm
2	038-2100	Colier de serrage, M10	19	026-4090	Ecrou de blocage, M16
3	042-6100	Dent, ø10 mm	20	023-5350	Boulon acier, M12 x 35 mm
4	101-2510	Plateau de serrage, M10	21	027-2270	Rondelle biseautée, ø12 mm
5	026-4060	Ecrou de blocage, M10	22	103-2730	Section de boulonnage, modèle 1
6	091-0500	Dent compl. (pos. 2 - 5)	22	103-2740	Section de boulonnage, modèle 2
7	038-2120	Colier de serrage, M12	23	103-2810	Attelage compl., modèle 1 (pos. 7 - 22)
8	101-2590	Arc creux	23	103-2820	Attelage compl., modèle 2 (pos. 7 - 22)
9	026-4070	Ecrou de blocage, M12			
10	023-5360	Boulon acier, M12 x 40 mm			
11	037-7400	Goupille élastique, ø4 mm			
12	101-1580	Broche, ø13 mm			
13	101-2570	Bras de traction			

KULTURHARVE
S - PINNEHARV
SPRING TINE HARROW
FEDERZINKENEGGE
VIBROCULTEUR
ERPICE COLTIVATORE

DOUBLET
RECORD

LANGFINGEREFTERHARVE
LONG - FINGER - HARROW
ZUSTREICHEGGE
HERSE ARRIERE A DENTS

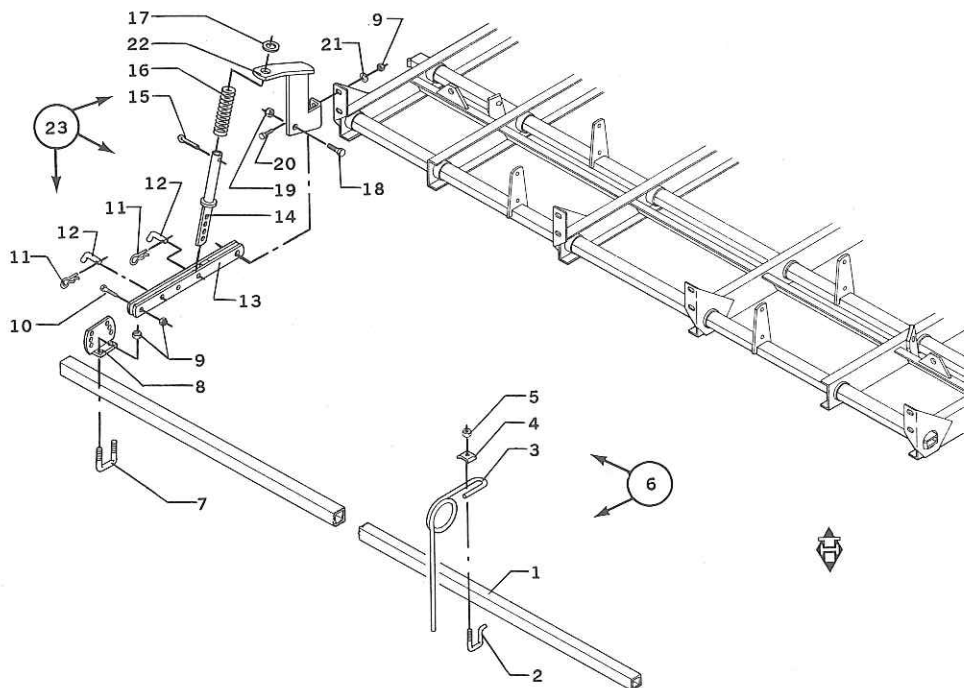

DANSK

1	103-2850	Bom til 0,60 m (570 mm)	12	101-1580	Nagle, \varnothing 13 mm
1	103-2870	Bom til 1,20 m (1170 mm)	13	101-2570	Trækarm
1	103-2890	Bom til 1,80 m (1770 mm)	14	103-2770	Fjederstyr
1	103-2910	Bom til 2,20 m (2170 mm)	15	037-3750	Split, \varnothing 10 x 60 mm
1	103-2950	Bom til 2,80 m (2770 mm)	16	043-1250	Trykfjeder, \varnothing 6 x 180 mm
2	038-2100	Spændebøjle, M10	17	027-2350	Facetskive, \varnothing 30 mm
3	042-6100	Langfingertand, \varnothing 10 mm	18	023-5800	Stålbolt, M16 x 45 mm
4	101-2510	Spændeplade, M10	19	026-4090	Låsemøtrik, M16
5	026-4060	Låsemøtrik, M10	20	023-5350	Stålbolt, M12 x 35 mm
6	091-0500	Komplet langfingertand (pos. 2 - 5)	21	027-2270	Facetskive, \varnothing 12 mm
7	038-2120	Spændebøjle, M12	22	103-2730	Påboltningstykke, Type 1
8	101-2590	Hulbue	22	103-2740	Påboltningstykke, Type 2
9	026-4070	Låsemøtrik, M12	23	103-2810	Komplet bespænding, Type 1 (pos. 7 - 22)
10	023-5360	Stålbolt, M12 x 40 mm	23	103-2820	Komplet bespænding, Type 2 (pos. 7 - 22)
11	037-7400	Hårnålesplit, \varnothing 4 mm			

ENGLISH

1	103-3850	Centre drawbar for 2.20 m	15	103-3640	Crossbar, short
1	103-3870	Centre drawbar for 2.80 m	15	103-3620	Crossbar, long
2	103-1160	Roller, 0.64 m	16	103-3790	Side frame drawbar f. 0.60 m
2	103-1200	Roller, 1.20 m	16	103-3810	Side frame drawbar f. 1.20 m
2	103-3560	Roller, 1.80 m	16	103-3830	Side frame drawbar f. 1.80 m, left
3	103-1100	Frame, 0.64 m			
3	103-1140	Frame, 1.20 m	16	103-4040	Side frame drawbar f. 1.80 m, right
3	103-3900	Frame, 1.80 m			
4	026-4070	Check nut, M12	17	023-5350	Steel bolt, M12 x 35 mm
5	027-2270	Facet disk, dia. 12 mm	18	103-2850	Bar for 0.64 m
6	047-8500	Flanged bearing, FL205, ø25	18	103-2870	Bar for 1.20 m
7	101-2010	Intermediate washer	18	103-2890	Bar for 1.80 m
8	102-6800	Clamp, M10	19	038-2120	Clamp, M12
9	023-5370	Steel bolt, M12 x 45 mm	20	103-3670	Adjusting piece
10	037-7400	Hairpin split-pin, dia. 4 mm	21	026-4060	Check nut, M10
11	101-1580	Spike, dia. 13 mm	22	101-2510	Retaining plate, M10
12	043-4020	Steel spring, 7 x 45 mm	23	038-2100	Clamp, M20
13	023-5380	Steel Ibolt, M12 x 50 mm	24	042-6100	Long finger tine, dia. 10 mm
14	103-3700	Drawbar, short	25	091-0500	Long finger tine, complete (pos. 21 - 24)
14	103-3720	Drawbar, long			

DEUTSCH

1	103-3850	Mittelzugrahmen für 2,20 m	15	103-3640	Diagonalstrebe, kurz
1	103-3870	Mittelzugrahmen für 2,80 m	15	103-3620	Diagonalstrebe, lang
2	103-1160	Walze, 0,64 m	16	103-3790	Seitenfeldzugrahmen f. 0,60m
2	103-1200	Walze, 1,20 m	16	103-3810	Seitenfeldzugrahmen f. 1,20m
2	103-3560	Walze, 1,80 m	16	103-3830	Seitenfeldzugrahmen für 1,80 m, left
3	103-1100	Rahmen, 0,64 m			
3	103-1140	Rahmen, 1,20 m	16	103-4040	Seitenfeldzugrahmen für 1,80 m, rechts
3	103-3900	Rahmen, 1,80 m			
4	026-4070	Gegenmutter, M12	17	023-5350	Stahlbolzen, M12 x 35 mm
5	027-2270	Facettenscheibe, ø12 mm	18	103-2850	Rahmen für 0,64 m
6	047-8500	Flanschenlager, FL205, ø25	18	103-2870	Rahmen für 1,20 m
7	101-2010	Zwischenscheibe	18	103-2890	Rahmen für 1,80 m
8	102-6800	Klammer, M10	19	038-2120	Klammer, M12
9	023-5370	Stahlbolzen, M12 x 45 mm	20	103-3670	Einstellbeschlag
10	037-7400	Haarnadelsplint, ø4 mm	21	026-4060	Gegenmutter, M10
11	101-1580	Bolzen, ø13 mm	22	101-2510	Spannplatte, M10
12	043-4020	Blattfeder, 7 x 45 mm	23	038-2100	Klammer, M20
13	023-5380	Stahlbolzen, M12 x 50 mm	24	042-6100	Zustreichzinken, ø10 mm
14	103-3700	Zugstange, kurz	25	091-0500	Zustreichzinken, komplett (Pos. 21 - 24)
14	103-3720	Zugstange, lang			

FRANCAIS

1	103-3850	Barre de traction centrale pour 2,20 m	14	103-3720	Tige d'attelage "Longue"
1	103-3870	Barre de traction centrale pour 2,80 m	15	103-3640	Traverse "Courte"
2	103-1160	Rouleau, 0,64 m	15	103-3620	Traverse "Longue"
2	103-1200	Rouleau, 1,20 m	16	103-3790	Barre de traction rallonge pour 0,60 m
2	103-3560	Rouleau, 1,80 m	16	103-3810	Barre de traction rallonge pour 1,20 m
3	103-1100	Bâti, 0,64 m	16	103-3830	Barre de traction rallonge pour 1,80 m, gauche
3	103-1140	Bâti, 1,20 m	16	103-4040	Barre de traction rallonge pour 1,80 m, droite
3	103-3900	Bâti, 1,80 m			
4	026-4070	Ecrou de blocage, M12	17	023-5350	Boulon acier, M12 x 35 mm
5	027-2270	Rondelle biseautée, ø12 mm	18	103-2850	Barre 0,64 m
6	047-8500	Roulement à billes, FL205, ø25	18	103-2870	Barre 1,20 m
7	101-2010	Rondelle intermédiaire	18	103-2890	Barre 1,80 m
8	102-6800	Colier de serrage, M10	19	038-2120	Colier de serrage, M12
9	023-5370	Boulon acier, M12 x 45 mm	20	103-3670	Pièce de réglage
10	037-7400	Goupille élastique, ø4 mm	21	026-4060	Ecrou de blocage, M10
11	101-1580	Broche, ø13 mm	22	101-2510	Plateau de serrage, M10
12	043-4020	Ressort à lame, 7 x 45 mm	23	038-2100	Colier de serrage, M20
13	023-5380	Boulon acier, M12 x 50 mm	24	042-6100	Dent, ø10 mm
14	103-3700	Tige d'attelage "Courte"	25	091-0500	Dent, compl. (pos. 21 - 24)

KULTURHARVE
S - PINNEHARV
SPRING TINE HARROW
FEDERZINKENEGGE
VIBROCULTEUR
ERPICE COLTIVATORE

**DOUBLET
RECORD**

KOMBI-EFTERHARVE
FINGER / ROLLER COMBINATION
KOMBI-NACHLAUFER
HERSE ARRIERE COMBI

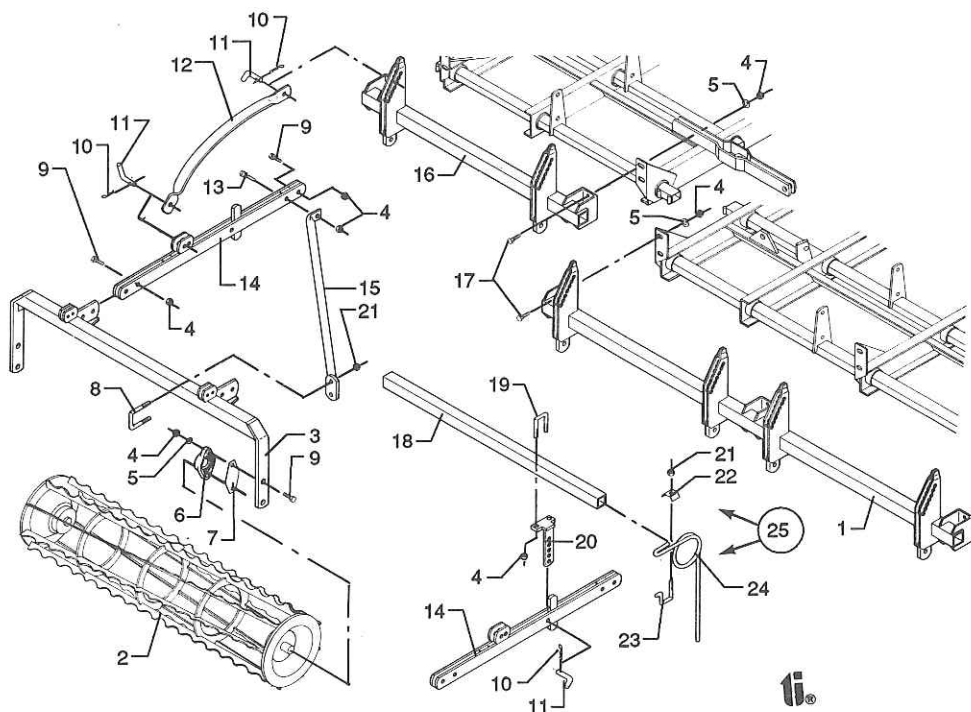

DANSK

- 1 103-3850 Midtertrækbom til 2,20 m
- 1 103-3870 Midtertrækbom til 2,80 m
- 2 103-1160 Rulle, 0,64 m
- 2 103-1200 Rulle, 1,20 m
- 2 103-3560 Rulle, 1,80 m
- 3 103-1100 Ramme, 0,64 m
- 3 103-1140 Ramme, 1,20 m
- 3 103-3900 Ramme, 1,80 m
- 4 026-4070 Låsemøtrik, M12
- 5 027-2270 Facetskive, ø12 mm
- 6 047-8500 Flangeleje, FL205, ø25
- 7 101-2010 Mellemlægsskive
- 8 102-6800 Spændebøjle, M10
- 9 023-5370 Stålbolt, M12 x 45 mm
- 10 037-7400 Hårnålesplit, ø4 mm
- 11 101-1580 Nagle, ø13 mm
- 12 043-4020 Bladfjeder, 7 x 45 mm
- 13 023-5380 Stålbolt, M12 x 50 mm
- 14 103-3700 Trækstang, kort
- 14 103-3720 Trækstang, lang

- 15 103-3640 Skrastiver, kort
- 15 103-3620 Skrastiver, lang
- 16 103-3790 Vingetrækbom til 0,60 m
- 16 103-3810 Vingetrækbom til 1,20 m
- 16 103-3830 Vingetrækbom til 1,80 m, venstre
- 16 103-4040 Vingetrækbom til 1,80 m, højre
- 17 023-5350 Stålbolt, M12 x 35 mm
- 18 103-2850 Bom til 0,64 m
- 18 103-2870 Bom til 1,20 m
- 18 103-2890 Bom til 1,80 m
- 19 038-2120 Spændebøjle, M12
- 20 103-3670 Stillestykke
- 21 026-4060 Låsemøtrik, M10
- 22 101-2510 Spændeplyde, M10
- 23 038-2100 Spændebøjle, M20
- 24 042-6100 Langfingertand, ø10 mm
- 25 091-0500 Komplet langfingertand (pos. 21 - 24)

EC-DECLARATION OF CONFORMITY

DOUBLET-RECORD A/S
ØRDING
DK-7990 Ø. ASSELS
Tlf.: 45 97 76 61 00

hereby declare that:

MACHINE: **Harrow**

TYPE: **Kulti-Dan**

NO.:

was manufactured in conformity with the provisions in the COUNCIL DIRECTIVE of 14 June 1989 on mutual approximation of the laws of the Member States on the safety of machines (89/392/EEC as amended by directive 91/368 EEC) with special reference to Annex 1 of the Directive on essential safety and health requirements in relation to the construction and manufacture of machines.

Manager Henning Petersen

Doublet-Record A/S

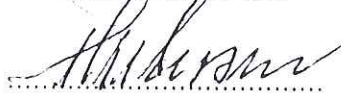

signature

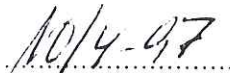

date

Doublet-Record A/S , Doubletvej 2, Ørding, DK-7990 Ø. Assels

EF-OVERENSSTEMMELSESERKLÆRING

DOUBLET-RECORD A/S
ØRDING
DK-7990 Ø. ASSELS
Tlf.: 97 76 61 00

erklærer hermed, at:

MASKINE: **Harve**

TYPE: **Kulti-Dan**

NR.:

er fremstillet i overensstemmelse med bestemmelserne i RÅDETS DIREKTIV af 14. juni 1989 om indbyrdes tilnærmelse af medlemsstaternes lovgivning om maskiner (89/392/EØF og ændret ved 91/368/EØF) under særlig henvisning til direktivets bilag I om væsentlige sikkerheds-og sundhedskrav i forbindelse med konstruktion og fremstilling af maskiner.

Direktør ~~Henning~~ Petersen

~~Doublet-Record~~ A/S

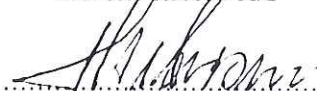

Underskrift

10/4-97

dato

Doublet-Record A/S , Doubletvej 2, Ørding, DK-7990 Ø. Assels

EG-KONFORMITÄTSERKLÄRUNG

DOUBLET-RECORD A/S
ØRDING
DK-7990 Ø. ASSELS
Tlf.: 45 97 76 61 00

erklären hiermit, dass:

MASCHINE: **Egge**

TYP: **Kulti-Dan**

NR.:

in Übereinstimmung mit den Bestimmungen der RICHTLINE DES RATES vom 14. Juni 1989 zur Angleichung der Rechtsvorschriften der Mitgliedstaaten für Maschinen (89/392/EWG, geändert durch die Richtlinie 91/368/EWG) unter besonderem Hinweis auf Anhang 1 der Richtlinie über grundlegende Sicherheits- und Gesundheitsanforderungen bei Konzipierung und Bau von Maschinen, hergestellt wurde.

Direktør Henning Petersen

Doublet-Record A/S



.....
Unterschrift

10/4-97
.....

Datum

DÉCLARATION CE DE CONFORMITÉ

DOUBLET-RECORD A/S
ØRDING
DK-7990 Ø. ASSELS
TIF.: 45 97 76 61 00

déclare par la présente que:

MACHINE: **Herse**

TYPE: **Kulti-Dan**

NR.:

a été construite en conformité avec les dispositions de la DIRECTIVE DU CONSEIL du 14 juin 1989 concernant le rapprochement des législations des Etats membres relatives aux machine (89/392/CEE modifiée par la directive 91/368/CEE) avec référence particulière à l'annexe 1 de la directive concernant les exigences essentielles de sécurité et de santé relatives à la conception et à la construction des machines.

Henning Petersen, p.d.g.

Doublet-Record A/S

.....
Signature

.....
date

Doublet-Record A/S, Doubletvej 2, Ørding, DK-7990 Ø. Assels

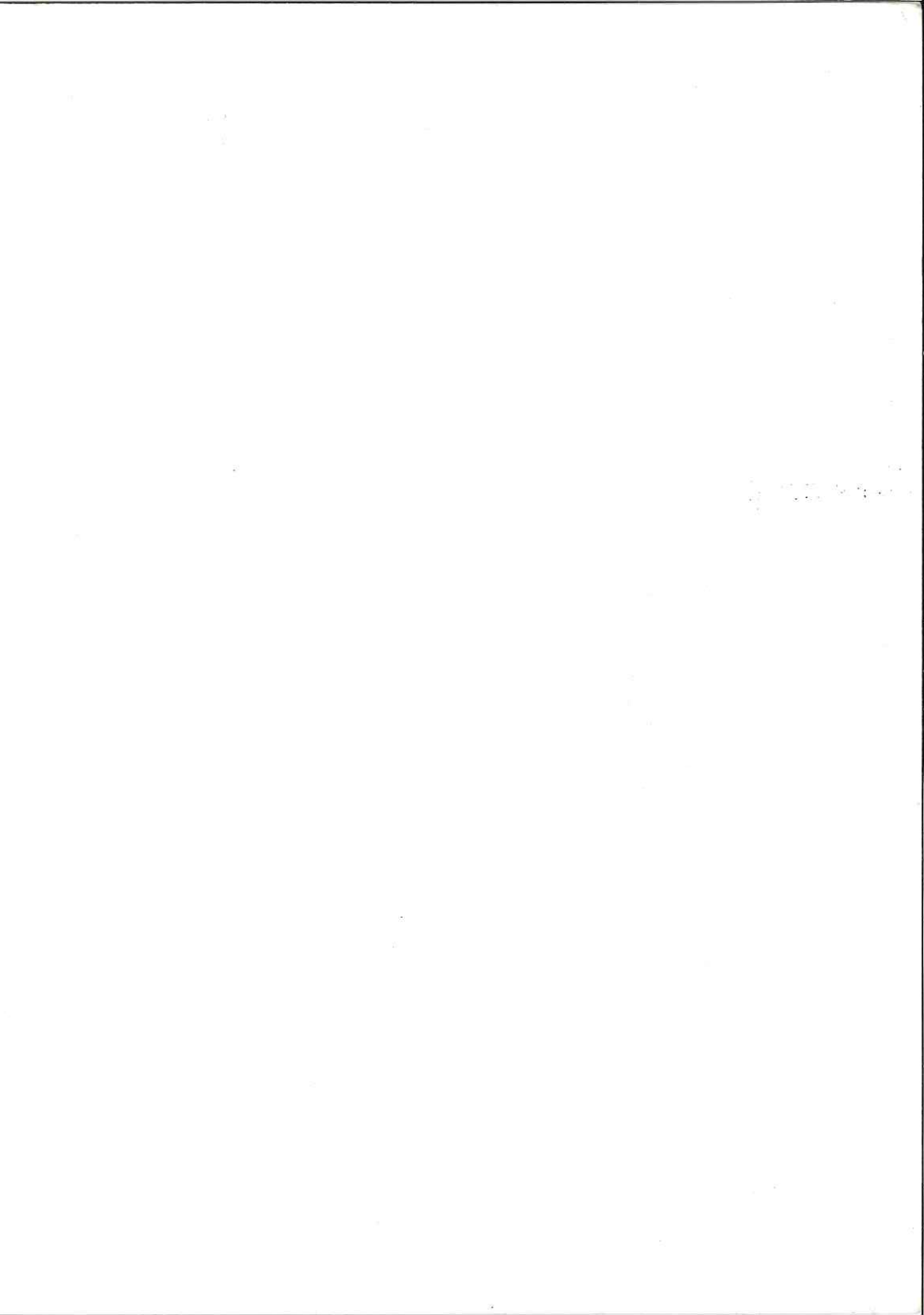

Ret til ændring i konstruktion og mål uden avis forbeholdes.

We reserve the right to change specifications, construction, etc., without notice or without liability.

Sämtliche Abbildungen und techn. Angaben unverbindlich. Konstruktionsänderungen vorbehalten.

Les caractéristiques techniques sont données à titre indicatif et nous nous réservons le droit de les modifier sans préavis.

Tutte le illustrazioni e informazioni tecniche sono senza impegno. Con riserva di modifiche di costruzione.