

HE-VA

Assembly Instruction
Operating Instruction
Spare Parts List

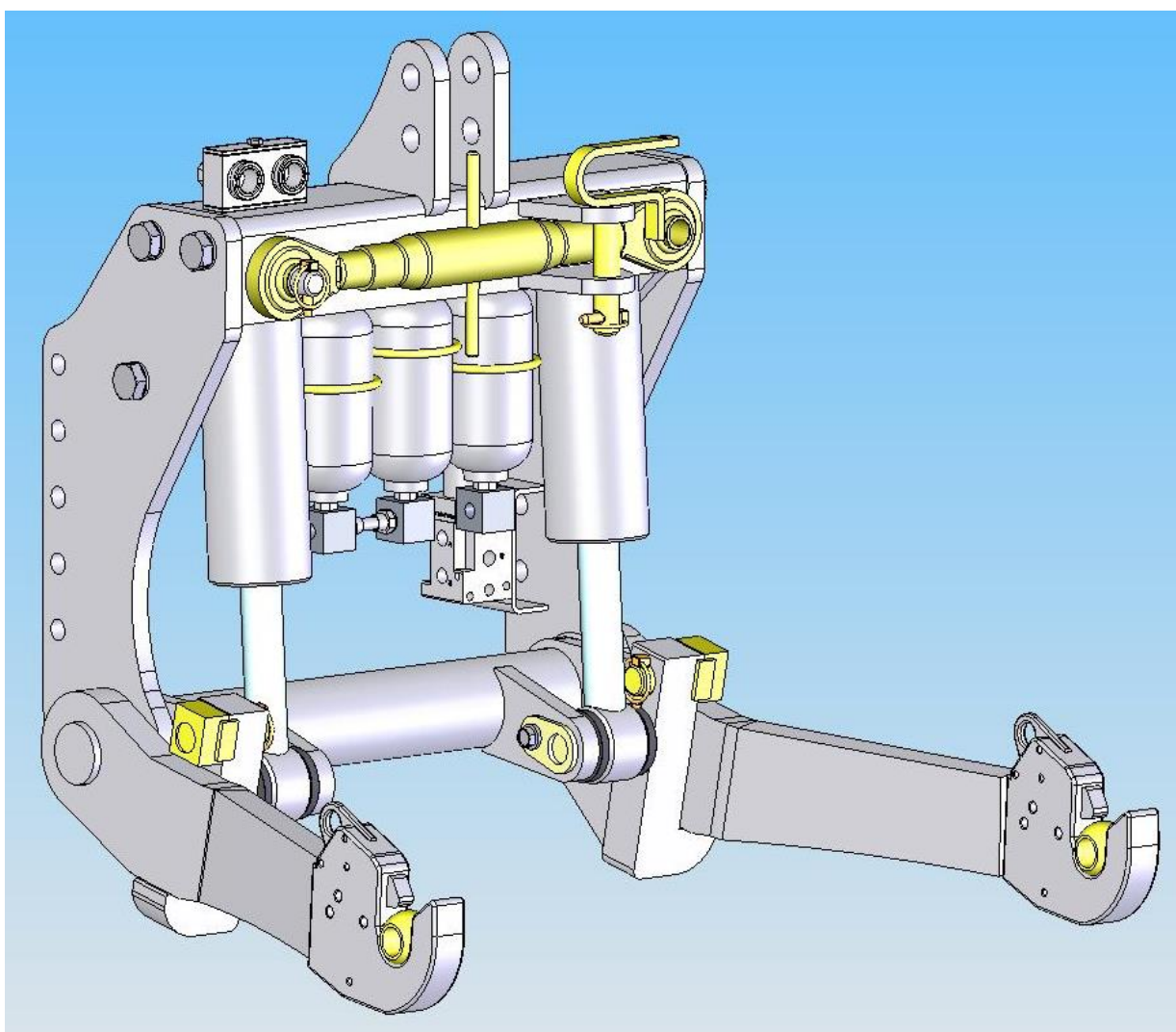

Front-Lift
Type 25.01 & 36.01

Contents

*

EC DECLARATION OF CONFORMITY	1
1. Delivery Check	2
2. Machine Description.....	2
2.1 Application.....	2
2.2. Technical Specifications	2
3. Mounting Instruction	3
3.1 Generally.....	3
3.2 Mounting of Front-Lift	3
3.3 Mounting of Absorber, Spring Suspension and Double-acting Hydraulics	4
3.4 Mounting of Double-acting Hydraulics	4
3.5 Mounting of Absorber (ST)	4
3.6 Mounting of Spring Suspension (AF).....	4
4 Operating Instructions.....	5
4.1 Lift Arms.....	5
4.2 Coupling of Tool.....	5
4.3 Uncoupling of Tool.....	5
4.4 Lubrication.....	5
4.5 Maintenance.....	6
4.6 Locking Pin for Lift Arms	6
5. Spare Parts list	7
6. Hydraulic	9
6.1 Single acting hydraulic	9
6.2 Single acting hydraulic with absorber	10
6.3 Double acting hydraulic.....	11
6.4 Double acting hydraulic with suspension	12
6.5 Double acting hydraulic with schock absorber.....	13
6.6 Double acting hydraulic with absorber and spring suspension.....	14
7. Security	15
8. Notes:	16



EC DECLARATION OF CONFORMITY

in accordance with the EU Machinery Directive 2006/42/EC
applicable as from December 29th 2009:

HE-VA ApS
N. A. Christensensvej 34,
DK-7900 Nykøbing Mors

hereby confirms that the following machine has been manufactured in accordance with the Council
Directive 2006/42/EC.

The declaration comprises the following machine:

Front-Lift type 25.01
Front-Lift type 36.01

Nykøbing the 29th December 2009

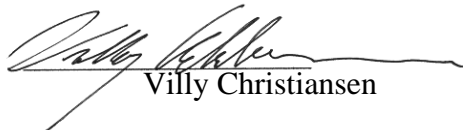

Villy Christiansen

The undersigned is furthermore authorised to compile technical documentation for the above machine.

HE-VA ApS does not assume any responsibility for damages to the tractor.

1. Delivery Check

- Both on delivery to the distributor/supplier and to the customer, the Front-Lift must be checked on any damages.

Check the hydraulic hoses on cuts and squeezing damages. Check that the other hydraulic components have not been damaged in transit.

2. Machine Description

2.1 Application

The Front-Lift is for mounting at the front of tractors. The Front-Lift is developed for a variety of various tractor models and may be equipped with short or long side members according to the tractor design. Absorbers, spring suspension and double-acting hydraulics can be fitted as accessories. In the Front-Lift, different tools can be fitted: roller, land-packer, harrow, sweeper, snow plough, etc. With the Front-Lift, the tools can be lifted and lowered and put in the required working position. When working with swinging land-packers, etc., causing considerable torsional stresses in the Front-Lift and the tractor, the additional support of the lift arms must be used. HE-VA delivers such additional support as accessories. **If the tractor is exposed to such torsional stresses, HE-VA does not assume any responsibility for damages to the tractor.**

NOTICE! The Front-Lift must not be used for passenger transport.

2.2. Technical Specifications

	Type 25.01	Type 36.01
Lifting capacity at an oil pressure of 190 bar	25 kN	36 kN
Maximum load in coupling eyes	25 kN	36 kN
Quick-couplings standard	1/2" cone type ISO 7241	1/2" cone type ISO 7241
Hydraulic oil: The system is filled up	Hydro Texaco Rando HD32	Hydro Texaco Rando HD32
Noise level	below 70 dB (A)	below 70 dB (A)

The Front-Lift complies with DS/ISO 8759/2, Nov. 86 as regards the dimensions, locations and lifting height (category II) of the coupling points. 825 mm between the quick-couplings/Ø28 mm pin.

3. Mounting Instruction

3.1 Generally

As standard the Front-Lift is supplied with a complete mounting kit consisting of bolts, nuts, washers, hydraulic hoses, quick-couplings and cable binders/strips.

3.2 Mounting of Front-Lift

The following mounting instruction is a general instruction in the mounting of a HE-VA Front-Lift. There may be deviations in special cases, and if in doubt, please contact HE-VA.

1. Dismantle the basic weight of the tractor.
2. Dismantle the lift in one side so that the side plates can pass the front block.
3. Mount the first side plate and tighten slightly.
4. Mount the second side plate and tighten slightly.
5. Mount the top lever attachment, cylinders and lifting console.
6. Now tighten all bolts. Remember it is very important that the bolts are lubricated in order to achieve adequate tightening. See the table.
7. Fit the hydraulic hoses to the hydraulic tractor PTO. The hoses must not hang loose but must be attached e.g. by means of strong cable binders/strips. The hoses may not touch any sharp edges, which may damage them. Pay special attention in connection with the movements of the front end.
8. With Front-Lifts with spring system the manometer with test hose must be fitted to a place visible from the driver's seat (e.g. on the guard).
9. It may be necessary to adjust the control swing after the mounting of the Front-Lift depending on the tyre fitting and wheel distance.

NOTICE! No hydraulic hoses may be fitted in the driver's cab.

When connecting the hydraulics there must be accordance between the movements of the hydraulic lever and the movement of the Front-Lift!

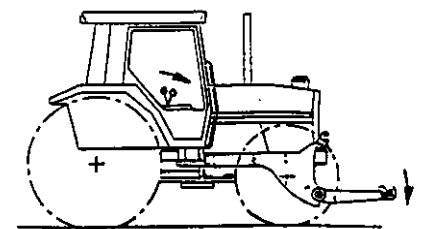
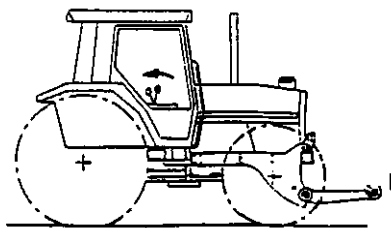
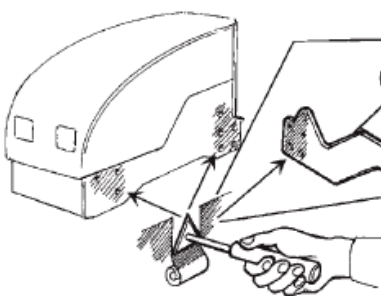

Remove all paint before mounting the sideplates/brackets

Metrical Thread	Tightening Torques in Nm. with oil-lubricated thread		
	Grade 8.8	Grade 10.9	Grade 12.9
M12	81	114	136
M14	128	181	217
M16	197	277	333
M18	275	386	463
M20	385	541	649
M22	518	728	874
M24	665	935	1120

3.3 Mounting of Absorber, Spring Suspension and Double-acting Hydraulics

Generally

As standard the Front-Lift is equipped with single-acting hydraulics and **not** equipped with absorber, spring suspension and double-acting hydraulics. These are available as accessories. HE-VA supplies the accessories in sets, which are thus ready for mounting.

The purpose of the absorber (ST) is to absorb the hardest impacts when driving with lifted tools on uneven surfaces. With double-acting hydraulics, the weight can be transferred from the tractor onto the tool. In this connection we recommend that the Front-Lift is equipped with a spring suspension system (AF), thus achieving a shock-absorbing connection with the tractor and the tool.

3.4 Mounting of Double-acting Hydraulics

When mounting double-acting hydraulics, the filter plugs are removed from the cylinders, and fittings and hydraulic hoses are fitted. The cylinders are prepared for the double-acting system.

3.5 Mounting of Absorber (ST)

The accumulator (1 pc.) is fitted on the lifting side of the cylinders in accordance with the diagrams.

3.6 Mounting of Spring Suspension (AF)

The accumulators (2 pcs.) are fitted with 1 pc. on the lifting side and 1 pc. on the lowering side of the cylinders in accordance with the diagrams

Important !

Before the hydraulic system is dismantled, the system must be depressurised. Be especially careful if the Front-Lift is equipped with accumulators (ST-AF).

When a dismantling of the hydraulic system is required, the Front-Lift must be totally lowered. Any tools must be placed on a firm support. Stop the tractor and move the control handles of the Front-Lift backwards and forwards until no more oil is flowing to back to the tractor.

Important !

After the mounting of accessories, the Front-Lift hydraulic system must be flushed so that shavings from the used cutting ring fittings are removed and will not cause any damage to the tractor hydraulic system.

4 Operating Instructions

4.1 Lift Arms

The rest position of the lift arms may either be vertical or backwards and depends on the tractor design. For vertical rest position the supplied lock fittings must be used and fitted when the lift is lowered. The lift arms will be locked when the lift is lifted to top position.

In rest position backwards, the arms must be tipped manually up until they hit the limit stop, and no locking fittings must be used.

4.2 Coupling of Tool

Fit the balls on the tool, drive the tractor into position and lift the Front-Lift so that the quick-couplings catch the tool.

4.3 Uncoupling of Tool

We recommend that you place the tool on a plane ground. The locking mechanism is released when the tool is hanging freely and then the Front-Lift is lowered.

Warning !

When the tractor motor is started, no persons may stay within the reach of the tractor, Front-Lift or mounted Tool.

4.4 Lubrication

When lubricating the Front-Lift and any mounted tool, lower the Front-Lift, brake the tractor, stop the motor and remove the ignition key!

There are 6 lubricating points on the Front-Lift, which must be lubricated after every 25 hours of operation, and 2 lubricating points on the Front-Lift, which must be lubricated after every 8 hours of operation, and after each cleaning in order to press any water out of the bearings.

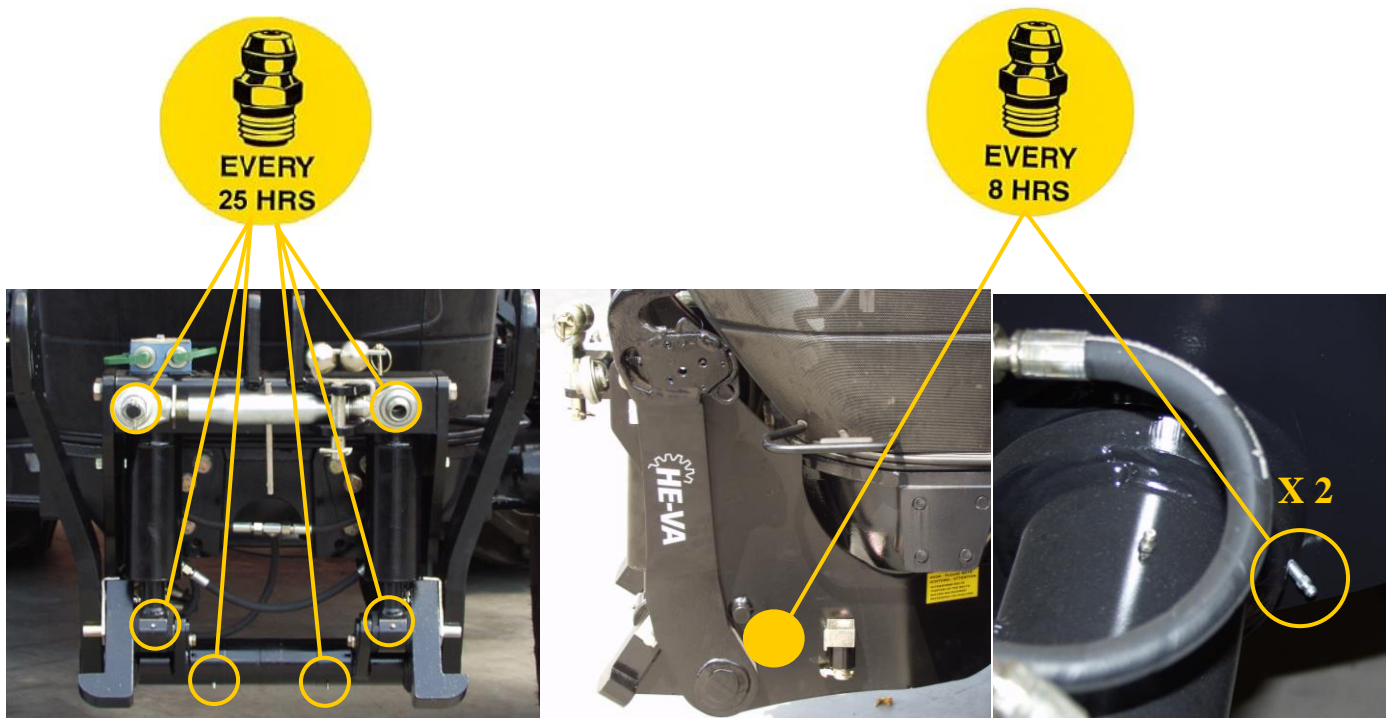

4.5 Maintenance

Retighten all bolts after the first 10 hours of operation. Check cylinders, hoses and fittings on leaks and retighten.

Then check that the Front-Lift bolts are tightened and that the hydraulic system does not leak oil.

In case of a standstill of some duration the Front-Lift should be lifted to protect the piston rods. If this is not possible (if a tool has been mounted), the protruding part of the piston rods should be lubricated in grease.

4.6 Locking Pin for Lift Arms

By fitting the locking pin in various ways, the movability of the arms can be determined. The various possibilities are shown below.

Locking Pin for Lift Arm

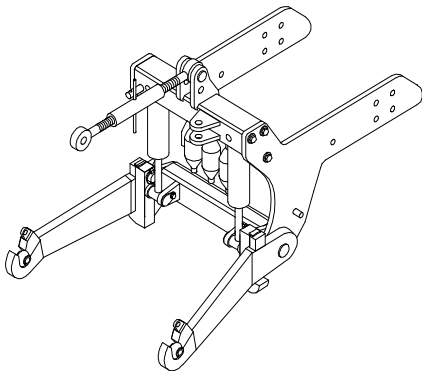

Locking Pin for vertical rest position.

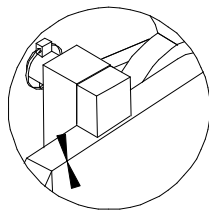

The lift arms are locked.
No mutual movability.

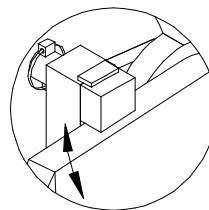

Turn the locking pin 1/4 turn.
Then there is mutual movability, however limited

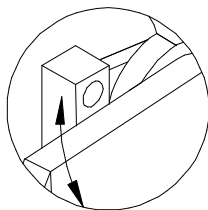

Remove the locking pin to achieve full movability. Place the pin in the bracket.

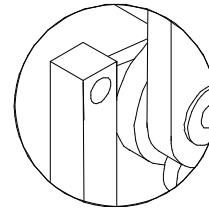

Put up the arms if the Front-Lift is not used for a period of some duration.

5. Spare Parts list

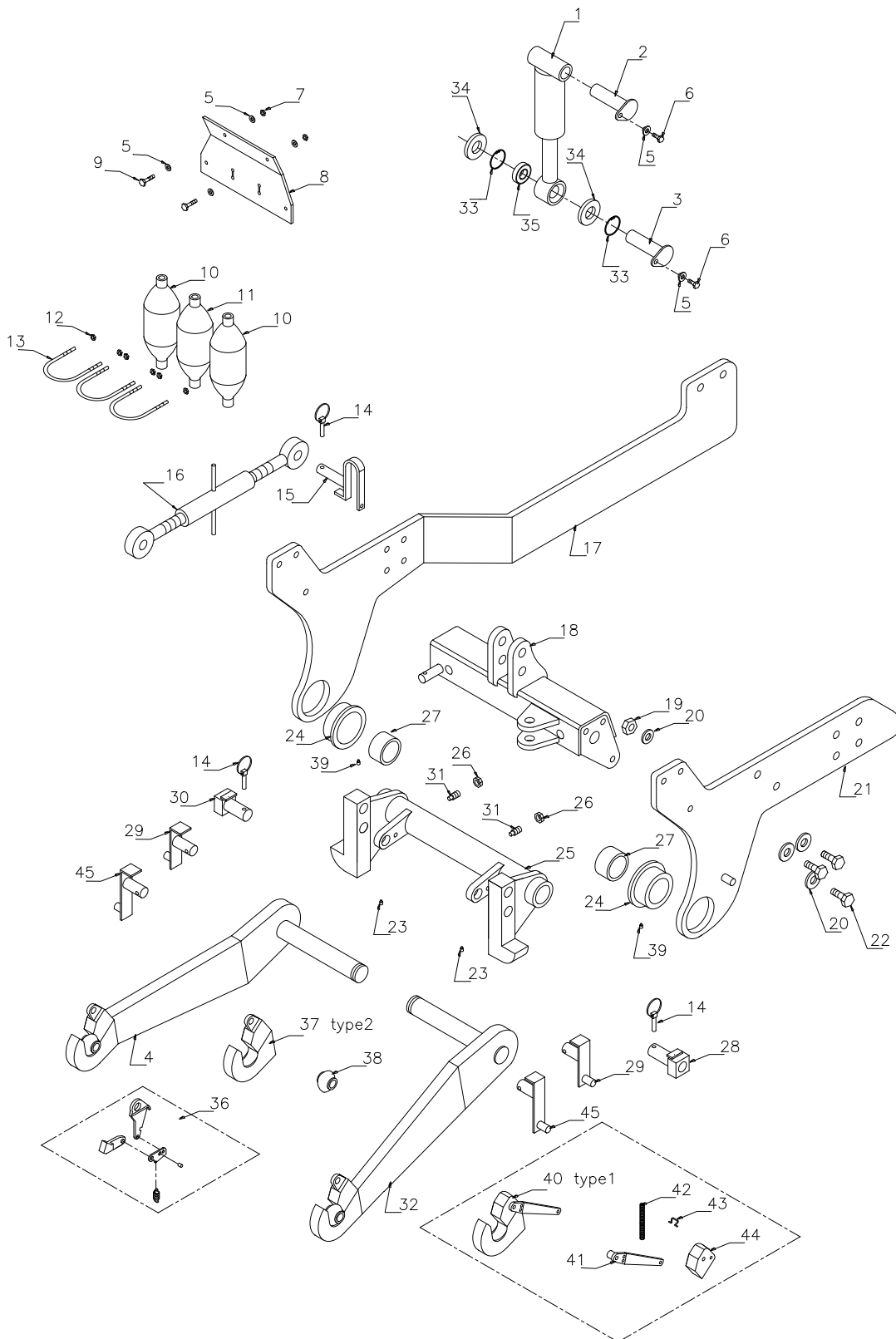

Pos.	Stk.	25.01	36.01	Betegnelse	
1	2	-	690200260	Cylinder Ø90/40 SL = 155	<i>Specify colour</i>
1a	2	-	690200272	Gasket set Ø90/40 (Faroil) Screwed together with 10 mm high head on the guide bush.	
1b	2		690200268	Gasket set Ø90/40 (Klinkby) Screwed together with 5 mm highhead on the guide bush	
1c	2		690200274	Gaske set Ø90/40 (Laizhou) Screwed together. Item number marked in the guide bush	
1	2	690200127	-	Cylinder Ø80/40 SL = 155	<i>Specify colour</i>
1a	2	690200138		Gasket set Ø80/40 (Hem) assembled with circlip ring	
1b	2	690200142	-	Gasket set Ø80/40 (Klinkby) Screwed together with 5 mm high head on the guide bush.	
1c	2	690200143		Gasket set Ø80/40 Laizhou) Screwed together. Item number marked in the guide bush	
2	2	665004005	665004005	Cylinder pin Ø35 L = 138	
3	2	665004009	665004009	Cylinder pin Ø35 L = 138, with hinge bearing	
4	2	665003010	667003004	Lift arm, right, complete, after 01-08-2012 (35 mm plate)	<i>Specify colour</i>
4	1	665003010	667003004	Lift arm, right, complete, after June 2002	<i>Specify colour</i>
4a	1	665003001	667003004	Lift arm, right, complete, before June 2002	<i>Specify colour</i>
5	4	630532600	630532600	Lock bush for pin head	
6	4	690101101	690101101	Set screw M12x25	
7	2	690113006	690113006	M12 locking nut	
8	1	665004002	665004002	Mounting plate for accumulators	<i>Specify colour</i>
9	2	690101103	690101103	M12x35 set screw	
10	2	690206403	690206403	Accumulator H700R-15 bar	<i>Specify colour</i>
11	1	690206430	690206430	Accumulator H700R- 100 bar	<i>Specify colour</i>
12	6	690113004	690113004	Locking nut M8	
13	3	690110001	690110001	U-bolt M8xØ92	
14	3	690134004	690134004	Pin, Ø10	
15	1	69525104B	69525104B	Top link pin Ø25	
16	1	690302010	690302011	Top link	
17	2	Forhør	Forhør	Side plate, right, long model	<i>Specify colour</i>
18	1	665001000	667001000	Top link console, before June 2002	<i>Specify colour</i>
18a	1	667001000	667001000	Top link console, after June 2002	<i>Specify colour</i>
19	2	690113009	690113009	M20 self locking nut	
20	8	690117005	690117005	Ø20 Spacer	
21	2	Forhør	Forhør	Side plate, right, short model	<i>Specify colour</i>
22	6	690101166	690101166	M20x60 10.9 screw	
23	2	690136001	690136001	Grease zerk M6	
24	2	667004003	667004003	Bearing housing, after June 2002 (welded in side plate)Ø104,5xØ90	
24a	2	665004003	667004003	Bearing housing, before June 2002 (welded in side plate)	
25	1	665002000	667002000	Lifting console, before June 2002	<i>Specify colour</i>
25a	1	667002000	667002000	Lifting console, after June 2002	<i>Specify colour</i>
26	2	690112101	690112101	M16, lock nut	
27	2	667004001	667004001	Bearing Ø90/Ø85 L= 30 ENDED	
27	2	667004002	667004002	Bearing Ø90/Ø85 L= 30 (Bronze)	
27a	2	665004001		Bearing Ø80/Ø75 L= 30 Befor June 2002	
27c	4	665004000	-	Bearing Ø55/Ø50 L= 40 Before June 2002	
28	1	663400404	663400404	Locking pin for link arm, left	
29	2	665004007	665004007	Locking pin for rest position, center distance 63 mm (standard for 25.01-36.01)	
30	1	663400405	663400405	Locking pin for link arm, right	
31	2	690104001	690104001	Stop screw M16x35	
32	1	665003011	667003014	Lift arm, left, complete, after 01-08-2012 (35mm plate)	
32	1	665003011	667003014	Lift arm, left, complete, after June 2002	<i>Specify colour</i>
32a	1	665003000	667003014	Lift arm, left, complete, before June 2002	<i>Specify colour</i>
33	4	691370014	691370014	Locking ring ø55, indv.	<i>Specify colour</i>
34	4	690141086	690141086	Sealing ring	
35	2	690140762	690140762	Bearing GE35DO2RS	
36	2	690106010	690106010	Repair kit for quick couplung, kat2, type2	
37	2	690106008	690106008	Quick couplung kat 2, type2	
38	2	690134005	690134005	Ball, kat 2	
39	2	690136002	690136002	Grease zerk M6, long	
40	2	690106006	690106006	Quick couplung, kat 2, type1	
41	2	690106005	690106005	Release lever for quick couplung, type1	
42	2	690106003	690106003	Spring for quick couplung, type1	
43	2	690106002	690106002	Spring clamp for quick couplung, type1	
44	2	690106004	690106004	Locking part for quick couplung, type 1	
45	2	667083001	667083001	Locking pin for rest position, center distance 93 mm	

6. Hydraulic

6.1 Single acting hydraulic

Pos.	Stk.	25.01	36.01	Betegnelse
1	1	690210001	690210001	Dust cap , blue
2	1	690203001	690203001	Quick couplung, male E402
3	1	690203102	690203102	Fitting 12x3/8" with O-ring
4	2	690206001	690206001	Filterplug, F38, 3/8"
5	2	-	690200260	Cylinder Ø90/40 SL = 155 <i>Specify colour</i>
			690200272	Gasket set Ø90/40 (Faroil) Screwed together with 10 mm high head on the guide bush.
			690200268	Gasket set Ø90/40 (Klinkby) Screwed together with 5 mm highhead on the guide bush
			690200274	Gaske set Ø90/40 (Laizhou) Screwed together. Item number marked in the guide bush
5	2	690200127	-	Cylinder Ø80/40 SL = 155 <i>Specify colour</i>
		690200138		Gasket set Ø80/40 (Hem) assembled with circlip ring
		690200142		Gasket set Ø80/40 (Klinkby) Screwed together with 5 mm high head on the guide bush.
		690200143		Gasket set Ø80/40 Laizhou) Screwed together. Item number marked in the guide bush
6	1	690201310	690201310	Hydraulic hose 5500 mm 3/8" st/45
7	1	690203106	690203106	Angle fitting 12-3/8 " BSP
8	1	690203110	690203110	Cutting ring Ø12 mm
9	1	690203111	690203111	Union nut Ø12 mm
10	1	690203017	690203017	Fitting T12L, with O-ring
11	1	690201207	690201207	Hydraulic hose 400 mm 3/8" st/st
12	1	690203155	690203155	Fitting, 3/8"x1/2"
13	1	690202990	690202990	Ball valve 3/8" PN500 DN10

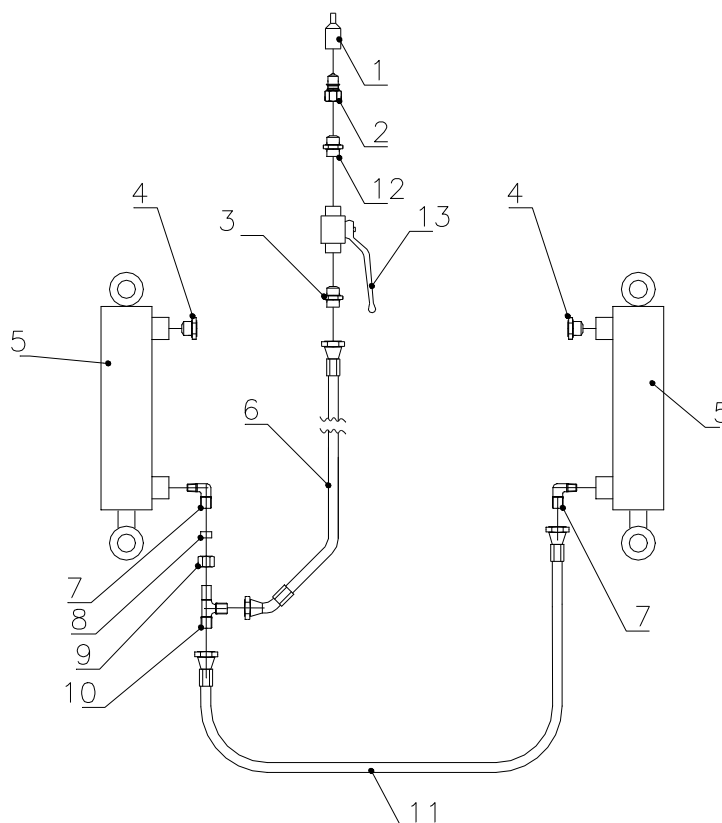

6.2 Single acting hydraulic with absorber

Pos.	Stk.	25.01	36.01	Betegnelse
1	1	690210001	690210001	Dust cap, blue
2	1	690203001	690203001	Quick couplung, male E402
3	1	690203155	690203155	Fitting 1/2"x3/8"
4	1	690201310	690201310	Hydraulic hose, 5500 mm 3/8" st/45
5	1	690206430	690206430	Accumulator H700R-100 bar <i>Specify colour</i>
6	1	690203102	690203102	Straight fitting 12-3/8" with O-ring
7	2	690206001	690206001	Filterplug, F38, 3/8"
8	2		690200260	Cylinder Ø90/40 SL = 155 <i>Specify colour</i>
			690200272	Gasket set Ø90/40 (Faroil) Screwed together with 10 mm high head on the guide bush.
			690200268	Gasket set Ø90/40 (Klinkby) Screwed together with 5 mm highhead on the guide bush
			690200274	Gasket set Ø90/40 (Laizhou) Screwed together. Item number marked in the guide bush
8	2	690200127		Cylinder Ø80/40 SL = 155 <i>Specify colour</i>
		690200138		Gasket set Ø80/40 (Hem) assembled with circlip ring
		690200142		Gasket set Ø80/40 (Klinkby) Screwed together with 5 mm high head on the guide bush.
		690200143		Gasket set Ø80/40 Laizhou) Screwed together. Item number marked in the guide bush
9	5	690203106	690203106	Angle fitting 12 - 3/8" BSP
10	1	660501400	660501400	Four square fitting 4x3/8 BSP tread
11	1	690201219	690201219	Hydraulic hose 350 mm 3/8" st/st
12	1	690203102	690203102	Fitting 12x3/8" med O-ring
13	1	690202990	690202990	Ball valve 3/8"

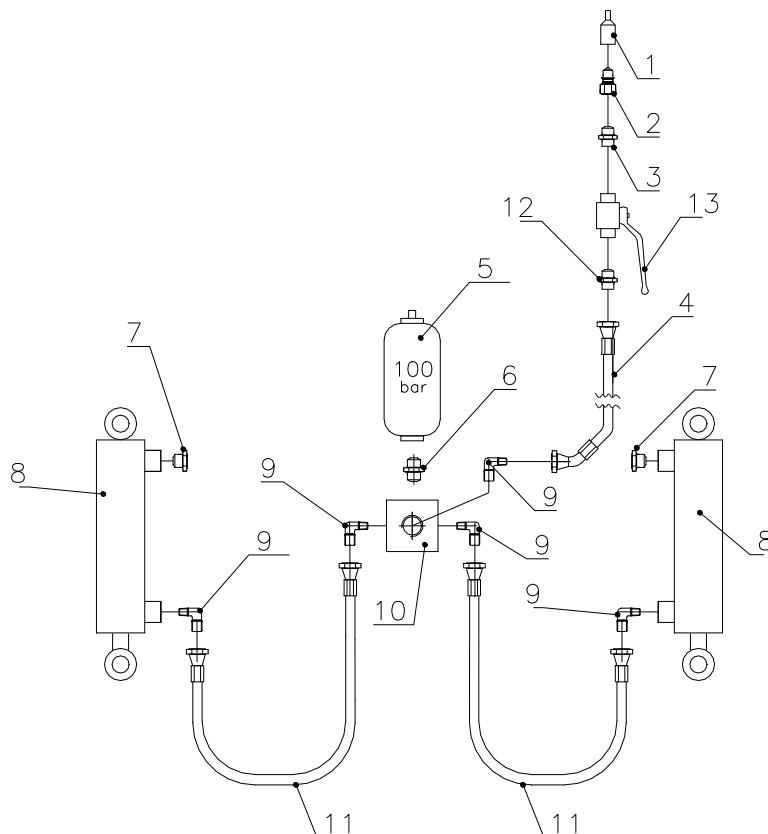

6.3 Double acting hydraulic

Pos.	Stk.	25.01	36.01	Betegnelse
1	2	690210001	690210001	Dust cap, blue
2	2	690203001	690203001	Quick couplung, male E402
3	1	690203155	690203155	Fitting 3/8"x1/2"
4	2	690201310	690201310	Hydraulic hose, 5500 mm 3/8" st/45
5	2	-	690200260	Cylinder Ø90/40 SL = 155 <i>Specify colour</i>
			690200272	Gasket set Ø90/40 (Faroil) Screwed together with 10 mm high head on the guide bush.
			690200268	Gasket set Ø90/40 (Klinkby) Screwed together with 5 mm highhead on the guide bush
			690200274	Gasket set Ø90/40 (Laizhou) Screwed together. Item number marked in the guide bush
5	2	690200127	-	Cylinder Ø80/40 SL = 155 <i>Specify colour</i>
		690200138		Gasket set Ø80/40 (Hem) assembled with circlip ring
		690200142		Gasket set Ø80/40 (Klinkby) Screwed together with 5 mm high head on the guide bush.
		690200143		Gasket set Ø80/40 (Laizhou) Screwed together. Item number marked in the guide bush
6	2	690201207	690201207	Hydraulic hose, 400 mm 3/8" st/45
7	4	690203106	690203106	Angle fitting 12 - 3/8" BSP
8	2	690203110	690203110	Cutting ring Ø12 mm
9	2	690203111	690203111	Union nut Ø12 mm
10	2	690203017	690203017	Fitting T12L mit O-ring
11	1	690203155	690203155	Fitting, 3/8"x1/2"
12	1	690202990	690202990	Ball valve 3/8" PN500 DN10

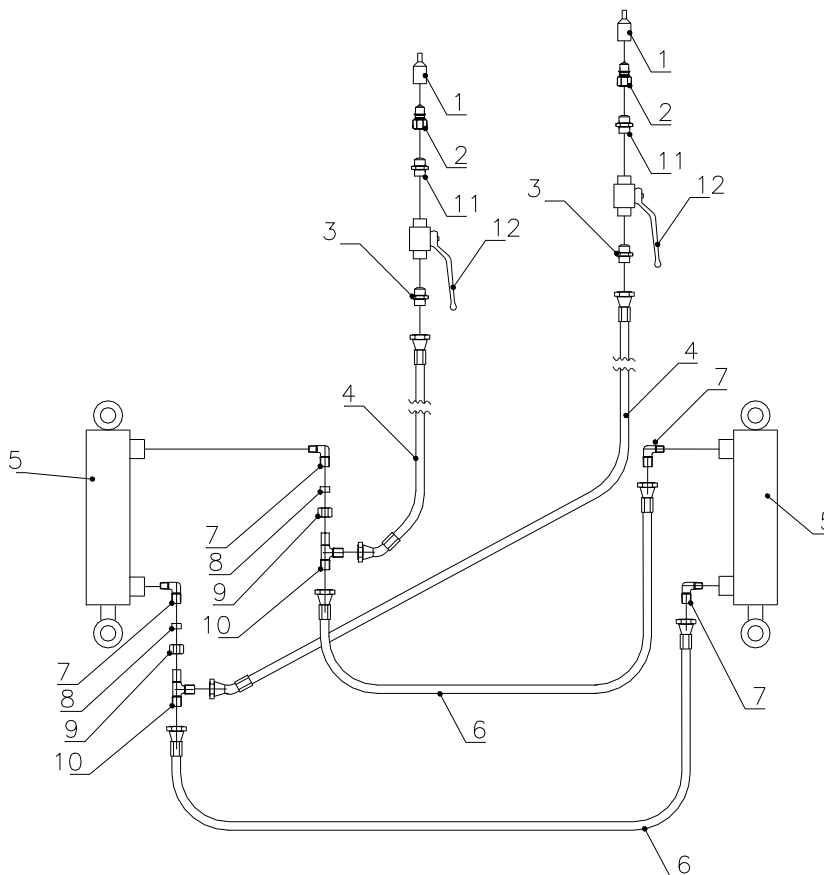

6.4 Double acting hydraulic with suspension

Pos.	Stk.	25.01	36.01	Description
1	2	690210001	690210001	Dust cap. blue
2	2	690203001	690203001	Quick couplung, male E402
3	1	690203155	690203155	Fitting 3/8"x1/2"
4	2	690201310	690201310	Hydraulic hose, 5500 mm 3/8" st/45
5	2	690206403	690206403	Accumulator H700R-15 bar <i>Specify colour</i>
6	2	690203102	690203102	Fitting 12 x 3/8" with O-ring
7	4	690203106	690203106	Angle fitting, 12 - 3/8" BSP
8	2	-	690200260	Cylinder Ø90/40 SL = 155 <i>Specify colour</i>
			690200272	Gasket set Ø90/40(Faroil) Screwed together with 10 mm high head on the guide bush.
			690200268	Gasket set Ø90/40 (Klinkby) Screwed together with 5 mm highhead on the guide bush
			690200274	Gasket set Ø90/40 (Laizhou) Screwed together. Item number marked in the guide bush
8	2	690200127	-	Cylinder Ø80/40 SL = 155 <i>Specify colour</i>
		690200138		Gasket set Ø80/40 (Hem) assembled with circlip ring
		690200142		Gasket set Ø80/40 (Klinkby) Screwed together with 5 mm high head on the guide bush.
		690200143		Gasket set Ø80/40 (Laizhou) Screwed together. Item number marked in the guide bush
9	3	690201223	690201223	Hydraulic hose 500 mm 3/8" st/st
10	2	660501400	660501400	Four square fitting 4x3/8 BSP tread
11	1	690201213	690201213	Hydraulic hose 300 mm 3/8" st/st
12	1	690203017	690203017	Fitting T12L, with O-ring
13	1	690203110	690203110	Cutting ring Ø12 mm
14	1	690203111	690203111	Union nut Ø12 mm
15	1	690203007	690203007	Test nipple for pressure gauge
16	1	690203008	690203008	Test hose for pressure gauge
17	1	690206802	690206802	Pressure gauge G63-D250B
18	1	690203155	690203155	Fitting, 3/8"x1/2"
19	1	690202990	690202990	Ball valve 3/8" PN500 DN10

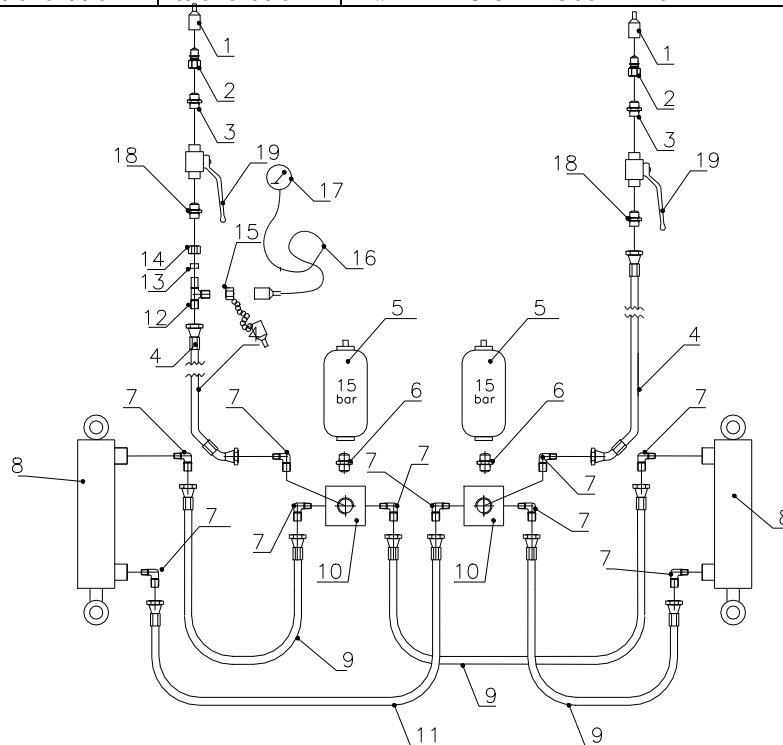

6.5 Double acting hydraulic with schock absorber

Pos.	Qty.	25.01	36.01	Description
1	2	690210001	690210001	Dust cap, blue
2	2	690203001	690203001	Quick couplung, male E402
3	1	690203155	690203155	Fitting 3/8" -x1/2"
4	2	690201310	690201310	Hydraulic hose, 5500 mm 3/8" st/45
5	1	690206430	690206430	Accumulator H700R-100 bar <i>Specify colour</i>
6	2	690203102	690203102	Fitting 12x3/8" with O-ring
7	4	690203106	690203106	Angle fitting, 12-3/8" BSP
8	2	-	690200260	Cylinder Ø90/40 SL = 155 <i>Specify colour</i>
			690200272	Gasket set Ø90/40(Faroil) Screwed together with 10 mm high head on the guide bush.
			690200268	Gasket set Ø90/40 (Klinkby) Screwed together with 5 mm highhead on the guide bush
			690200274	Gasket set Ø90/40 (Laizhou) Screwed together. Item number marked in the guide bush
8	2	690200127	-	Cylinder Ø80/40 SL = 155 <i>Specify colour</i>
		690200138		Gasket set Ø80/40 (Hem) assembled with circlip ring
		690200142		Gasket set Ø80/40 (Klinkby) Screwed together with 5 mm high head on the guide bush.
		690200143		Gasket set Ø80/40 (Laizhou) Screwed together. Item number marked in the guide bush
9	3	690201207	690201207	Hydraulic hose 400 mm 3/8" st/st
10	2	660501400	660501400	Four square fitting 4x3/8"BSP tread
11	1	690201219	690201219	Hydraulic hose 350 mm 3/8" st/st
12	1	690203110	690203110	Cutting ring Ø12 mm
13	1	690203111	690203111	Union nut Ø12 mm
14	1	690203017	690203017	Fitting T12L with O-ring
15	1	690203155	690203155	Fitting, 3/8"x1/2"
16	1	690202990	690202990	Ball valve 3/8" PN500 DN10

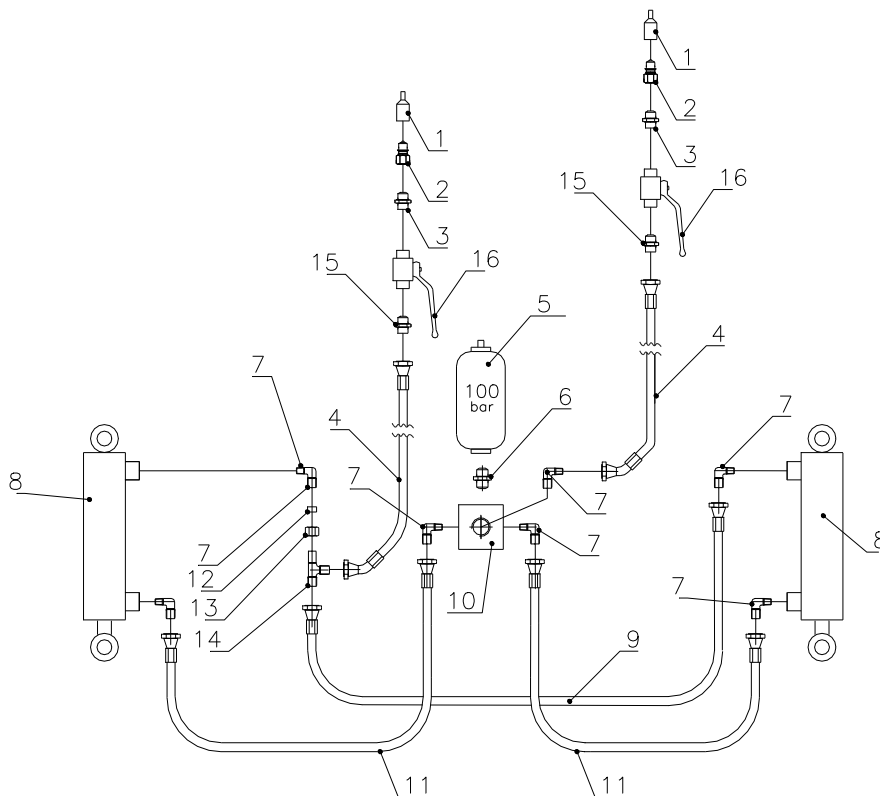

6.6 Double acting hydraulic with absorber and spring suspension

Pos.	Qty.	25.01	36.01	Description
1	2	690210001	690210001	Dust cap, blue
2	2	690203001	690203001	Quick couplung, male E402
3	1	690203155	690203155	Fitting 3/8"x1/2"
4	2	690201310	690201310	Hydraulic hose, 5500 mm 3/8" st/45
5	3	690203111	690203111	Union nut Ø12 mm
6	1	662000802	662000802	Hydraulikrør ø12 l= 35 mm
7	4	690203106	690203106	Angle fitting, 12 - 3/8" BSP
8	1	690203110	690203110	Cutting ring Ø12 mm
9	1	690206403	690206403	Accumulator O700R-15 bar <i>Specify colour</i>
10	2	660501300	660501300	Three square fitting 3x3/8" BSP tread
11	2	690203102	690203102	Straight fitting 12 x 3/8" with O-ring
12	1	690203017	690203017	Angle fitting,T12L, with O-ring
13	2	-	690200260	Cylinder Ø90/40 SL = 155 <i>Specify colour</i>
			690200272	Gasket set Ø90/40(Faroil) Screwed together with 10 mm high head on the guide bush.
			690200268	Gasket set Ø90/40 (Klinkby) Screwed together with 5 mm highhead on the guide bush
			690200274	Gasket set Ø90/40 (Laizhou) Screwed together. Item number marked in the guide bush
13	2	690200127	-	Cylinder Ø80/40 SL = 155 <i>Specify colour</i>
		690200138		Gasket set Ø80/40 (Hem) assembled with circlip ring
		690200142		Gasket set Ø80/40 (Klinkby) Screwed together with 5 mm high head on the guide bush.
		690200143		Gasket set Ø80/40 (Laizhou) Screwed together. Item number marked in the guide bush
14	1	690206430	690206430	Accumulator O700R-100 bar <i>Specify colour</i>
15	3	690201223	690201223	Hydraulic hose 500 mm 3/8" st/st
16	1	690201219	690201219	Hydraulic hose 350 mm 3/8" st/st
17	1	690203007	690203007	Test nipple for pressure gauge
18	1	690203008	690203008	Test hose for pressure gauge
19	1	690206802	690206802	Pressure gauge G63-D250B
20	1	660501400	660501400	Four square fitting 4x3/8" BSP tread
21	1	690203155	690203155	Fitting, 3/8"x1/2"
22	1	690202990	690202990	Ball valve 3/8" PN500 DN10

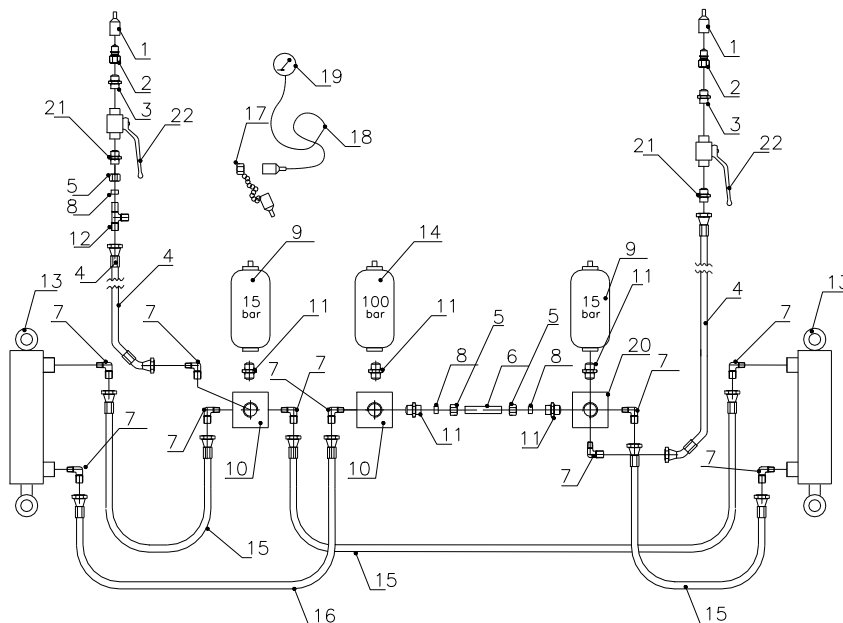

7. Security

Ved kørsel med sneplov og lignende:

Lås snapkoblinger med bolte

When operating a snow plough or similar equipment:

Lock the Quick Couplings with bolts

Pour l'emploi d'un chasse-neige ou outils pareils:

Verrouiller l'accouplement rapide avec boulons

Beim Betrieb einen Schneepflug oder ähnliche Geräte:

Verriegeln Sie die Schnellkupplungen mit Schrauben

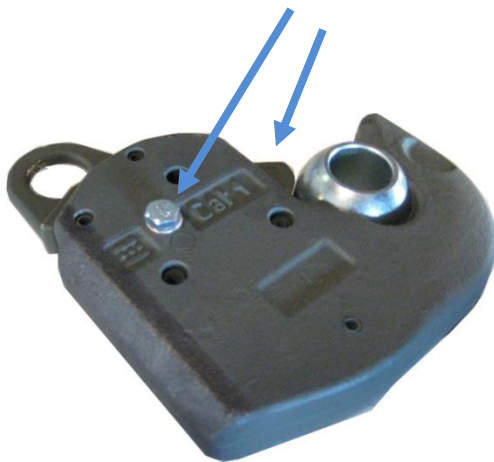

Snapkobling LÅST
Quick Coupling LOCKED
Accouplement rapide VERROUILLÉ
Schnellkupplung VERRIEGELT

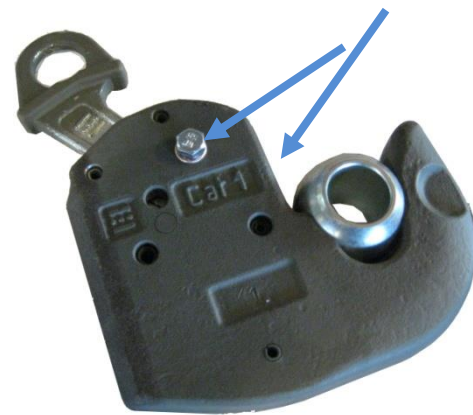

Snapkobling LÅST OP
Quick Coupling UNLOCKED
Accouplement rapide DÉVERROUILLÉ
Schnellkupplung ENTRIEGELT

Ved kørsel med snepløve og lignende skal snapkoblinger låses, for at forhindre skader på plov/redskaber og lift.

When operating a snow plough or similar equipment, the quick couplings must be locked to prevent damage to the equipment and the Frontlift.

Pour l'emploi d'un chasse-neige ou outils pareils, l'accouplement rapide doit être verrouillé pour éviter d'endommager l'outil et le relevage avant.

Beim Betrieb einer Schneepflug oder ähnliche Geräte, die Schnellkupplungen müssen verriegelt sein, um Schäden am Gerät und dem Frontkraftheber zu verhindern.

Front-Lift - Relevage avant Front-Lift - Frontkraftheber Front-Lift	8.01	15.01	25.01.	36.01	55.01
Bolt - skiver - møtrikker					
Bolts – washers - nuts					
Boulons – rondelles - écrous	M6 x 50	M6 x 50	M8 x 50	M8 x 50	M8 x 60
Bolzen - Scheiben - Muttern					

8. Notes:

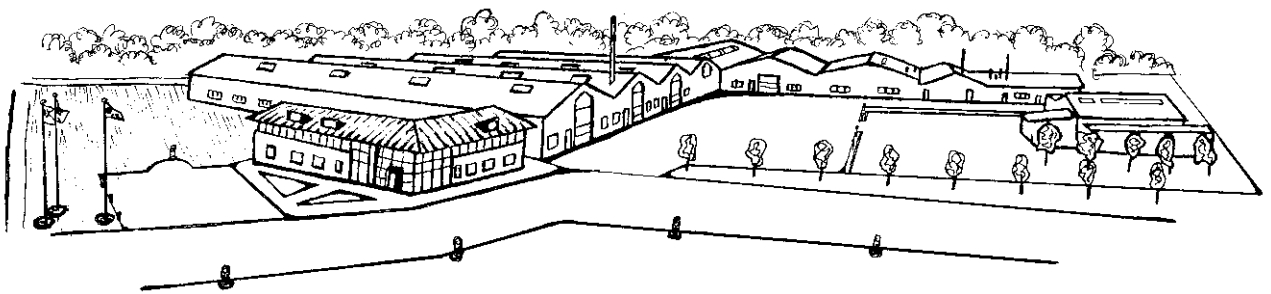

We reserve the right to make design modifications without previous notice.